

# Wireless 2-Axis Force Platform

PS-3230

**⚠ CAUTION:**

The Force Platform is designed for use by students under the supervision of a teacher. Ensure that all users understand and follow these guidelines when jumping or stepping on the platform:

- Do not stand on or jump off tables, chairs, or other inappropriate objects.
- Be certain that the platform will not skid or move when you jump on it.
- Always land with your feet entirely on the platform, not hanging over the edge.
- Use the platform away from objects that may interfere with your movements or injure you if you fall.

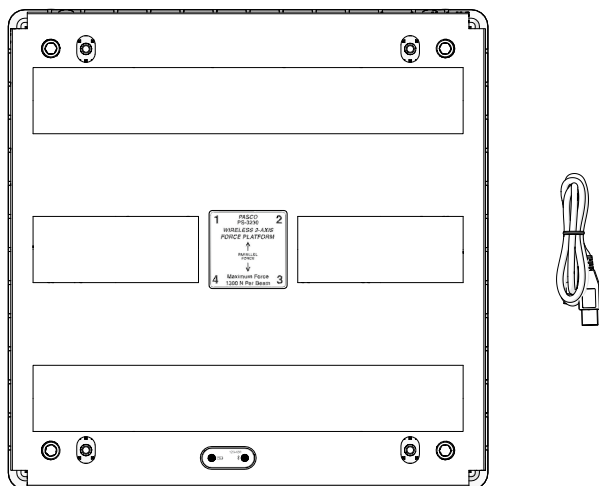

## What's included



- Wireless 2-Axis Force Platform
- USB Cable

## Getting started

### Charge the battery

Connect the Wireless 2-Axis Force Platform USB port  to a USB charger using the included USB cable. The battery light  displays yellow while charging and changes to green when fully charged.

### Get the software

You can use the Wireless 2-Axis Force Platform with SPARKvue or PASCO Capstone software. If you're not sure which app to use, visit [pasco.com/products/guides/software-comparison](https://www.pasco.com/products/guides/software-comparison) for help. SPARKvue is available as a free app for Chromebook, iOS, and Android devices. We offer a free trial of SPARKvue and Capstone for Windows and Mac.

#### WINDOWS AND MAC

#### CHROMEBOOK, IOS, AND ANDROID

Go to [pasco.com/downloads](https://www.pasco.com/downloads).

Search for SPARKvue in your device's app store.

If you already have the software, check that you have the latest update installed:

 **SPARKvue**

Go to the Main Menu  then select **Check for Updates**.

 **PASCO Capstone**

In the menu bar, click **Help** then select **Check for updates**.

## Connect to the software

### SPARKvue

1. Press and hold the power button  until the lights turn on.
2. Open SPARKvue.
3. Select **Sensor Data** on the Welcome Screen.



4. Select the Wireless 2-Axis Force Platform that matches its device ID.



**Important:** You may be prompted to update the firmware if a new version is available. If so, click **Yes** to update the firmware.

5. Select the measurements you want to display. **Normal Force** is selected by default.
6. Select a template to display the data.

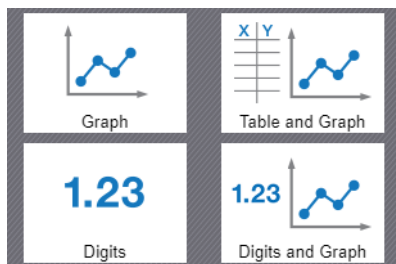

### PASCO Capstone

1. Press and hold the power button  until the lights turn on.
2. Open PASCO Capstone.
3. Click **Hardware Setup**.



4. Select the Wireless 2-Axis Force Platform that matches its device ID.



**Important:** You may be prompted to update the firmware if a new version is available. If so, click **Yes** to update the firmware.

5. Click **Hardware Setup** again to close the panel.
6. Click **Sensor Data** to display a graph of Normal Force versus Time.

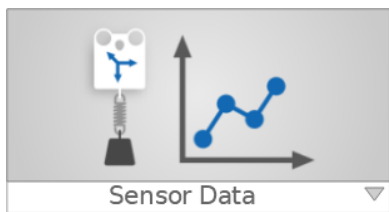



## Set up and collect data

### SPARKvue

1. Turn all four feet until they reach their maximum height.
2. Place the platform on the floor. Adjust the feet height so that all four feet make contact with the floor. You can either turn the feet or the hex bolt on the top of the platform.



**Note:** The sensor reports incorrect data if all four feet aren't in contact with the floor.

3. Without anything on the force platform, click zero  to tare the sensor.
4. Click **Start** .
5. Apply a force to the platform.
6. Click **Stop** .

### PASCO Capstone

1. Turn all four feet until they reach their maximum height.
2. Place the platform on the floor. Adjust the feet height so that all four feet make contact with the floor. You can either turn the feet or the hex bolt on the top of the platform.

**Note:** The sensor reports incorrect data if all four feet aren't in contact with the floor.

3. Without anything on the force platform, click zero  to tare the sensor.
4. Click **Record** .
5. Apply a force to the platform.
6. Click **Stop** .

If desired, increase the sample rate to view more data points. If the sample rate is too high, you may need to set a **recording condition** to trigger sampling. See the Capstone help for instructions on how to use recording conditions.

## Download an experiment

Download one of several student-ready activities from the PASCO Experiment Library. Experiments include editable student handouts and teacher notes. Go to [pasco.com/freelabs/PS-3230](https://www.pasco.com/freelabs/PS-3230).

If you want to explore on your own, check out the SPARKvue and PASCO Capstone help guides to search for specific topics.

### SPARKvue

Software: Go to the **Main Menu**  then select **Help**.

Online: [pasco.com/help/sparkvue](https://www.pasco.com/help/sparkvue)

### PASCO Capstone

Software: In the menu bar, click **Help** then select **PASCO Capstone Help**.

Online: [pasco.com/help/capstone](https://www.pasco.com/help/capstone)

# Features

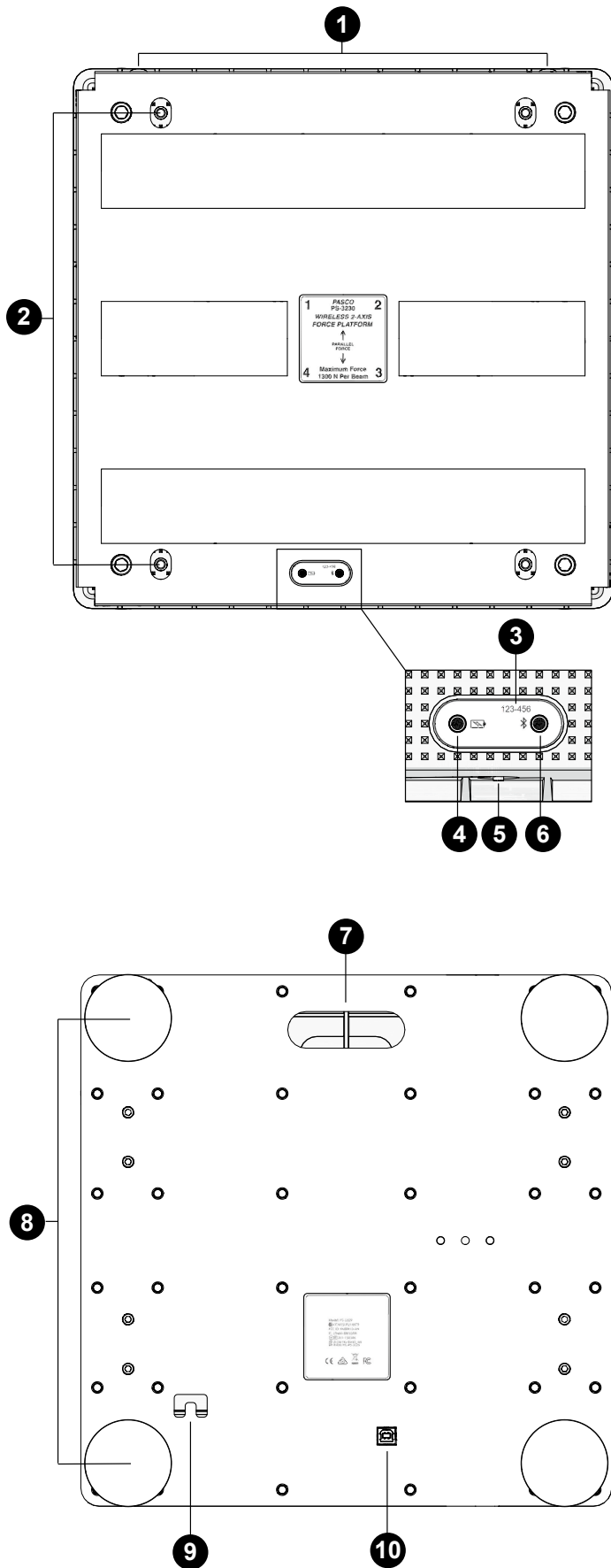

1. **Wall mounting holes**  
Use these holes to mount the force platform to a wall.
2. **Handle mounting holes**  
Use these holes to attach the Force Platform Handle Set (PS-2548) to the platform.
3. **Device ID**  
Use to identify the sensor when connecting using Bluetooth.
4. **Battery Status Light**   
Indicates the battery level and charging status.
 

LIGHT	STATUS
Red, blink	Low battery level
Green, solid	Fully charged
Yellow, solid	Charging
5. **Power Button**  
Press and hold for one second to turn the sensor on or off.
6. **Bluetooth Status Light**   
Indicates the status of the Bluetooth connection.
 

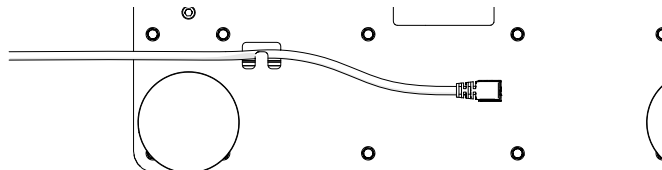
LIGHT	STATUS
Red, blink	Ready to pair
Green, blink	Paired
Yellow, blink	Remotely logging data
7. **Carry handle**  
Use the handle to carry the Force Platform with one hand.
8. **Feet and Force Beams**  
Each foot is attached to a force sensor and must be in contact with the surface to measure force. Additionally, the top of the foot must not be in contact with the force platform. Adjust the height by turning the feet by hand or turning the hex bolt on the top of the platform. The force beams are identified by the label on the top of the platform.
9. **Cable holder**  
Insert the USB cable through the recess to hold the cable in place.
 
10. **USB Port**  
Use with the USB cable to connect the platform to a USB wall charger to charge the battery. Also use to send measurement data to software when connected to a USB port of a computer or mobile device (iOS devices not supported).

## Horizontal setups

### With handles

Fasten the handles to the threaded brass inserts on the top of the platform. With the handles, you can hold the platform against a wall to measure horizontal pushing force.

 **Note:** The handles can't measure the Parallel Force.

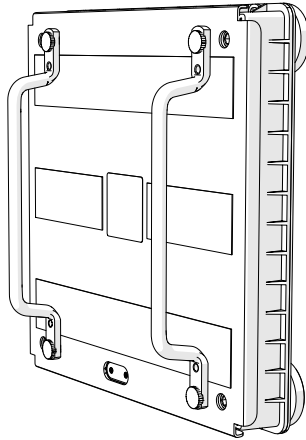

### On a wall

Use the holes on the top of the platform to hang from strings tied to a pair of bolts on a wall. All four feet must be in contact with the wall to measure force accurately.

 **Warning:** Attach the bolts to wall studs or drywall anchors that can support the weight of the platform. Use string rated to support the weight of the platform.

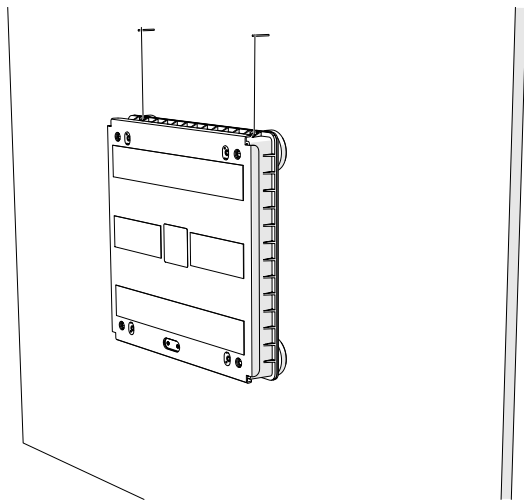

## Specifications and accessories

Visit the product page at [pasco.com/product/PS-3230](https://www.pasco.com/product/PS-3230) to view the specifications and explore accessories. Experiment files and support documents can also be found on the product page.

## Technical Support

Need more help? Our knowledgeable and friendly Technical Support staff is ready to provide assistance with this or any other PASCO product.

Phone (USA)	1-800-772-8700 (Option 4)
Phone (International)	+1 916 462 8384
Online	<a href="https://www.pasco.com/support">pasco.com/support</a>

## Regulatory information

### Warranty, Copyright, and Trademarks

#### Limited Warranty

For a description of the product warranty, see the Warranty and Returns page at [www.pasco.com/legal](https://www.pasco.com/legal).

#### Copyright

This document is copyrighted with all rights reserved. Permission is granted to non-profit educational institutions for reproduction of any part of this manual, providing the reproductions are used only in their laboratories and classrooms, and are not sold for profit. Reproduction under any other circumstances, without the written consent of PASCO scientific, is prohibited.

#### Trademarks

PASCO and PASCO scientific are trademarks or registered trademarks of PASCO scientific, in the United States and/or in other countries. All other brands, products, or service names are or may be trademarks or service marks of, and are used to identify, products or services of, their respective owners. For more information visit [www.pasco.com/legal](https://www.pasco.com/legal).

### Product end of life disposal instructions

 This electronic product is subject to disposal and recycling regulations that vary by country and region. It is your responsibility to recycle your electronic equipment per your local environmental laws and regulations to ensure that it will be recycled in a manner that protects human health and the environment. To find out where you can drop off your waste equipment for recycling, please contact your local waste recycle or disposal service, or the place where you purchased the product.

The European Union WEEE (Waste Electronic and Electrical Equipment) symbol on the product or its packaging indicates that this product must not be disposed of in a standard waste container.

### Battery disposal instructions

 Batteries contain chemicals that, if released, may affect the environment and human health. Batteries should be collected separately for recycling and recycled at a local hazardous material disposal location adhering to your country and local government regulations. To find out where you can drop off your waste battery for recycling, please contact your local waste disposal service, or the product representative. The battery used in this product is marked with the European Union symbol for waste batteries to indicate the need for the separate collection and recycling of batteries.

### FCC statement

This device complies with part 15 of the FCC Rules. Operation is subject to the following two conditions: (1) This device may not cause harmful interference, and (2) this device must accept any interference received, including interference that may cause undesired operation.

### CE statement

This device has been tested and found to comply with the essential requirements and other relevant provisions of the applicable EU Directives.