

# UV-VIS Spectrometer

SE-3607



## About the Product

Measure intensity, absorbance, transmittance across the visible and UV spectrum. After specifying a target wavelength, students can study concentrations (Beer's Law), rates of reactions, or investigate emission spectra using the optional fiber optic cable.

## What's Included

- UV-VIS Spectrometer
- 2× Cuvette Rack
- 10× Semi-Micro Cuvette with Cap
- AC Adapter
- USB Cable
- Spectrometry Software (online download)

## Recommended Items

- **Fiber Optic Cable Kit (SE-7182)**  
Required for analyzing emission spectra.

## Safety Instructions

### ⚠ CAUTION:



This product contains a high intensity ultraviolet light source. Always wear proper eye protection (UV blocking safety glasses) and skin protection when using this device.

- This instrument contains an internal high-voltage power source and a replaceable UV lamp assembly. Do not attempt to open or remove the case at any time except for servicing by qualified personnel only. Always make sure the unit is unplugged before servicing.
- Only use the power supply supplied with the product.
- Do not remove or modify any of the components of this device. Doing so will create an unsafe operating condition and will void the product warranty.
- Do not block the exhaust of the ventilator fan. After turning off the device, do not disconnect power until the fan stops running. Failure to follow these directions will damage the equipment.

### 📄 Notice:

- This is a precision measuring instrument. Avoid dropping or rough handling which can damage the unit or affect the measuring accuracy.
- Do not use this instrument if it is damaged in any way. Contact PASCO Technical Support for assistance.
- PASCO products are designed for educational use only. This product should not be used for clinical or professional diagnosis or industrial control.

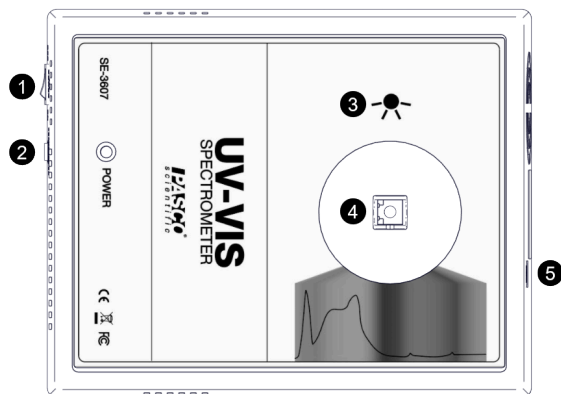

## Components

### 1 Power Switch

Use to turn the Spectrometer on and off.

### 2 Power Jack

Connect to an electrical outlet using the AC Adapter.

**CAUTION:** Do not disconnect from power until the fan stops running to avoid damage to the equipment.

### 3 Light Source Location

When inserting a cuvette that has only two smooth sides, make sure one of the smooth sides faces the light source.

### 4 Test Chamber

Insert a cuvette containing a solution or the Fiber Optics Cable.

### 5 USB Port

Connect to a computer USB port using the USB cable.

## Install Spectrometry Software

The latest version of Spectrometry software is required to use the Spectrometer. The UV-VIS Spectrometer can be used with a Windows or Mac computer. Download the software at [pasco.com/downloads](http://pasco.com/downloads).

## Connect to Spectrometry Software

1. Connect the AC adapter to the power jack on the spectrometer. Connect the other end to an electrical outlet.
2. Connect the USB cable to the USB port on the spectrometer. Connect the other end to a USB port on a computer.
3. Set the power switch to the on position to turn on the Spectrometer.
4. Open Spectrometry on your computer.

**Important:** You may receive a notification to install a firmware update. Click Yes to update the firmware if prompted.

## Warm-Up Time

Before collecting data, turn on the UV-VIS Spectrometer and allow it to warm up for 10 minutes. Measurements may fluctuate if the spectrometer is not provided with enough time to warm up.

## Prepare Solutions for Analysis

Solutions to be analyzed with the spectrometer need to be placed in cuvettes.

**CAUTION:** The semi-micro cuvettes are made from a proprietary polycyclical olefin that can be used with most polar solvents, acids, and alkaline solutions. Check your specific solvent for interactions before allowing samples to sit for any period of time in the spectrometer to avoid damaging the equipment.







**Note:** It is recommended to use quartz cuvettes (sold separately) when analyzing wavelengths below 220 nm.

- Fill the cuvette  $\frac{3}{4}$  full with the sample solution and cap the cuvette.
- Clean the smooth sides of the cuvette using a lint free wipe before inserting it into the spectrometer.
- When inserting a cuvette, make sure that the smooth side faces the light source.

You will also need to prepare a reference solution for calibration when preparing solutions for analysis. The reference solution should be the solvent used to make the sample solutions.







## Analyze the Absorbance of a Solution

Measure the wavelengths of light a solution absorbs and transmits.





1. Prepare the samples for analysis.
  - a. Fill the cuvettes  $\frac{3}{4}$  full with the sample solutions and cap.
  - b. Prepare a reference solution by filling one cuvette  $\frac{3}{4}$  full with the solvent used to make the sample solutions.
2. Connect the Spectrometer to Spectrometry.
3. Calibrate the spectrometer.
  - a. Select the Analyze Solution page .
  - b. Cover the spectrometer to block ambient light and click Calibrate Dark .
  - c. Insert the reference solution in the spectrometer then click Calibrate Reference .
4. Collect data.
  - a. Insert a sample in the spectrometer then click Record .
  - b. Use the Tools to adjust the smoothing and number of scans to average as needed.
  - c. Click Stop  when you are satisfied with the results.
5. Analyze the data.
  - a. Click  to use the coordinate tool locate the peak(s) for each sample.
  - b. Use the other graph tools as needed to perform further analysis.

## Determine the Concentration of a Solution

Determine the concentration of a solution by plotting absorbance versus concentration.













- Prepare the samples for analysis.
  - Fill the cuvettes  $\frac{3}{4}$  full with the sample solutions and cap.
  - Prepare a reference solution by filling one cuvette  $\frac{3}{4}$  full with the solvent used to make the sample solutions.
- Connect the Spectrometer to Spectrometry.
- Calibrate the spectrometer.
  - Select the Analyze Solution page .
  - Cover the spectrometer to block ambient light and click Calibrate Dark .
  - Insert the reference solution in the spectrometer then click Calibrate Reference .
- Select an Analysis Wavelength.
  - Place the most concentrated solution to be analyzed into the spectrometer then click Record .
  - Use the Tools to adjust the smoothing and number of scans to average as needed.
  - Click Stop  when you are satisfied with the results.
  - Drag the coordinate tool on the graph to the wavelength you want to analyze. This is usually a high point on the curve.
  - Once you have found a desirable wavelength click .
- Collect Data.
  - Select analyze Concentration from the menu at the top of the screen. A table will appear on the left side of the screen that has columns for Concentration and Absorbance.
  - Select the concentration cells in the column titled Concentration and type over the given values with the concentrations of the samples prepared.
  - Select Record to start analyzing the solution.
  - Place the highest-concentration sample into the spectrometer and click the cell in the Absorbance column that corresponds to the respective concentration. Once the absorbance stabilizes click  next to the absorbance to record the value.

 Note: A value of three indicates that the solution is too concentrated for the selected wavelength.

  - Repeat the previous step for the samples of lesser concentration and record their absorbance values.
  - Click Stop to stop data collection.
- Analyze Data.
  - Click  to remove the Live Scan Display from the graph.
  - Click Scale to Fit  to rescale your data.
  - Click Linear Fit  to create a best fit line and display the equation for the line.
  - Place the cuvette containing a solution of unknown concentration into the spectrometer.
  - Select the Absorbance cell in the Determine Unknown Concentration table at the bottom of the screen.
  - Click Record to start analyzing the solution.
  - Once the absorbance stabilizes click  next to the absorbance to record the value.
  - Click Stop to stop data collection.
  - Use either the graph or the equation of the line to determine the unknown concentration. Select the Concentration cell and enter the concentration.

## Determine Reaction Rate and Order

Determine reaction rate and order by plotting absorbance versus time.

- Prepare the samples for analysis.
  - Fill the cuvettes  $\frac{3}{4}$  full with the sample solutions and cap.
  - Prepare a reference solution by filling one cuvette  $\frac{3}{4}$  full with the solvent used to make the sample solutions.
- Connect the Spectrometer to Spectrometry.
- Calibrate the spectrometer.
  - Select the Analyze Solution page .
  - Cover the spectrometer to block ambient light and click Calibrate Dark .
  - Insert the reference solution in the spectrometer then click Calibrate Reference .
- Select an Analysis Wavelength.
  - Place the most concentrated solution to be analyzed into the spectrometer then click Record .
  - Use the Tools to adjust the smoothing and number of scans to average as needed.
  - Click Stop  when you are satisfied with the results.
  - Drag the coordinate tool on the graph to the wavelength you want to analyze. This is usually a high point on the curve.
  - Once you have found a desirable wavelength click .
- Collect Data.
  - Select analyze over Time  from the top of the screen.
  - Place the sample solution into the spectrometer and click Record .
  - Click Scale to Fit  to rescale your data. After allowing enough time for the reaction to take place, click Stop .
- Analyze Data.
  - Click  to remove the Live Scan Display from the graph.
  - Click Linear Fit  to create a best fit line and display the equation for the line.
  - Click Quick Calcs  on the y-axis to cycle the between Absorbance, ln(Absorbance), and 1/Absorbance to find a linear trend. Use the results to determine the order of reaction.

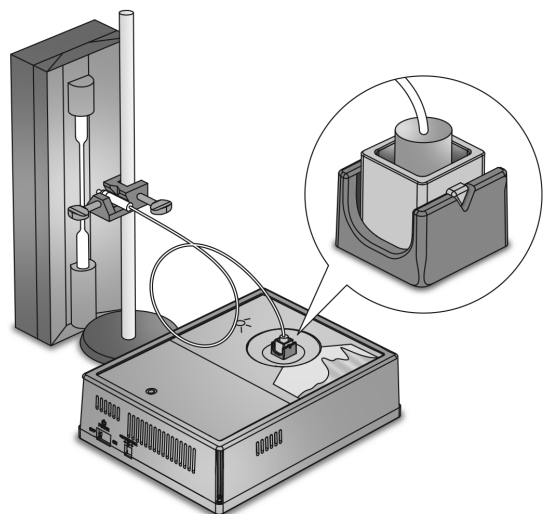

Figure 1. A setup showing the fiber optic cable installed in the UV-VIS Spectrometer and pointed at a light source.

## Analyze Emission Spectra

Determine the wavelengths of light emitted from sources such as gas spectrum tubes.

**Note:** The SE-7182 Fiber Optic Cable Kit is required to perform this procedure.

### Setup



1. Insert the fiber optic cable into the reflective cuvette.
2. Place the nut on the cable over the threads in the cuvette and turn the nut until finger tight.
3. Insert the reflective cuvette into the UV-VIS Spectrometer. Align the triangle on the cuvette with the notch on the test chamber (Figure 1).

**CAUTION:** It is important that the cuvette is aligned correctly. Incorrect alignment may result in the fiber optic cable pointing at the UV light source instead of the light sensor.



4. Point the other end of the fiber optic cable at a light source.

**Tip:** Attach the end of the cable to a stand. Place the probe as close to the source as possible without touching the source.

### Collecting Data

1. Open the Spectrometry app.
2. Connect the UV-VIS Spectrometer to Spectrometry.
3. Select Analyze Light .
4. Click Record .

**Tip:** Click Auto Set under Integration Time if the data is too noisy.

5. Click Stop  to keep the data.
6. Use the Coordinates Tool  to measure peak wavelengths.

## Spectrometry Software Help

Additional information on how to use the Spectrometer can be found in the Spectrometry Help.

- **Spectrometry:** Click  then select Help.
- **Online:** Go to [pasco.com/help/spectrometry](https://www.pasco.com/help/spectrometry).

## Additional Information

Visit the product web page at [pasco.com/product/se-3607](https://www.pasco.com/product/se-3607) for additional information including:

- Specifications
- Buying Guide (Accessories, Replacement Parts)
- Experiments
- Documents (Knowledge Base, Safety Sheets)

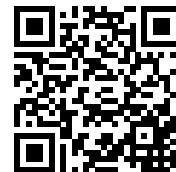

## Technical Support

Need more help? Our knowledgeable and friendly Technical Support staff is ready to provide assistance with this or any other PASCO product.

Phone 1-800-772-8700 (Option 4)  
+1 916 462 8384

Online [pasco.com/support](https://www.pasco.com/support)

## Warranty, Copyright, and Trademarks

### Limited Warranty

For a description of the product warranty, see the Warranty and Returns page at [www.pasco.com/legal](https://www.pasco.com/legal).

### Copyright

This document is copyrighted with all rights reserved. Permission is granted to non-profit educational institutions for reproduction of any part of this manual, providing the reproductions are used only in their laboratories and classrooms, and are not sold for profit. Reproduction under any other circumstances, without the written consent of PASCO scientific, is prohibited.

### Trademarks

PASCO and PASCO scientific are trademarks or registered trademarks of PASCO scientific, in the United States and/or in other countries. All other brands, products, or service names are or may be trademarks or service marks of, and are used to identify, products or services of, their respective owners. For more information visit [www.pasco.com/legal](https://www.pasco.com/legal).

## Product End of Life Disposal Instructions



This electronic product is subject to disposal and recycling regulations that vary by country and region. It is your responsibility to recycle your electronic equipment per your local environmental laws and regulations to ensure that it will be recycled in a manner that protects human health and the environment. To find out where you can drop off your waste equipment for recycling, please contact your local waste recycle or disposal service, or the place where you purchased the product.

The European Union WEEE (Waste Electrical and Electrical Equipment) symbol and on the product or its packaging indicates that this product must not be disposed of in a standard waste container.

## FCC Statement

This device complies with part 15 of the FCC Rules. Operation is subject to the following two conditions: (1) This device may not cause harmful interference, and (2) this device must accept any interference received, including interference that may cause undesired operation.

## CE Statement

This device has been tested and found to comply with the essential requirements and other relevant provisions of the applicable EU Directives.