

Wireless Current Sensor

PS-3212

WARNING: DO NOT CONNECT THE WIRELESS CURRENT SENSOR DIRECTLY ACROSS A BATTERY OR OTHER VOLTAGE SOURCE. MAKE SURE THAT THERE IS A RESISTOR OR SOME KIND OF “LOAD” IN SERIES WITH THE SENSOR. SEE PAGE 3.

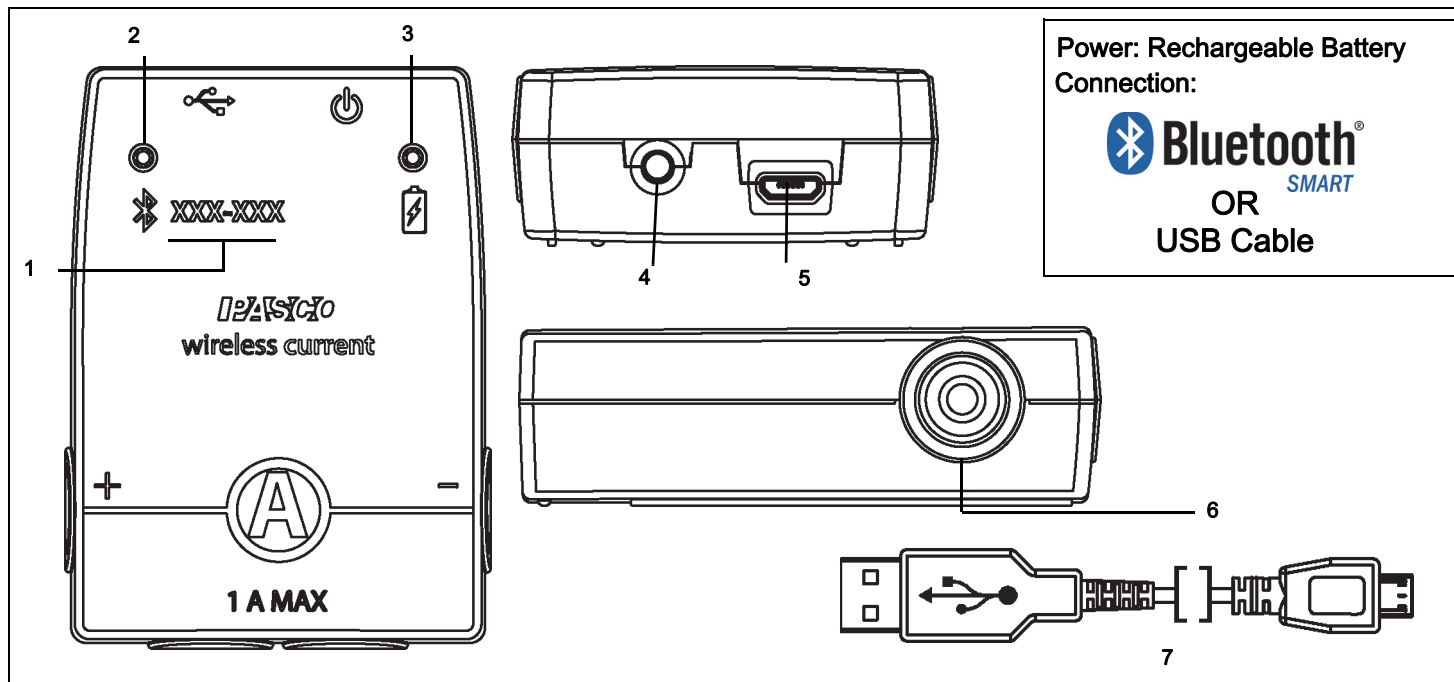

1	Device ID Number	5	Micro USB Port
2	Bluetooth Status LED	6	Red Test Lead Jack
3	Battery Status LED	7	Micro USB Cable
4	ON Button		

Hardware

Included Equipment	Part Number
Wireless Current Sensor	PS-3212
Micro USB Cable (1 meter)	



Introduction

The Wireless Current Sensor is a combination wireless and USB sensor that connects to a computer or tablet

device through BluetoothSM, and can also connect to a computer with a USB cable (included). The sensor measures current in two ranges: between -1 ampere (A) and +1 A, and between - 0.1 A and + 0.1 A. The PASCO Data Collection Software will display and analyze the measurements from the sensor. NOTE: The software also supports “remote data logging” for long term experiments.

The sensor is designed to optimize the battery usage time. Since each sensor has a unique Device ID number, more than one can be connected to a computer or tablet at the same time.

Data Collection Software

PASCO Capstone	SPARKvue
	
<ul style="list-style-type: none"> • Mac OS X • Windows 	<ul style="list-style-type: none"> • Mac OS X • Windows • iOS • Android • Chromebook

See the PASCO Web page at

www.pasco.com/software

for help in selecting the right PASCO software and to check the latest versions.

Software Help

See the SPARKvue Help or PASCO Capstone Help for information about collecting, displaying, and analyzing data.

- In SPARKvue, select the HELP button in any screen including the Home Screen.
- In PASCO Capstone, select PASCO Capstone Help from the Help menu, or press F1.

Bluetooth[®] Compatibility

Check the PASCO Web page at

www.pasco.com/compatibility

for the latest information.

Platform	Bluetooth SMART Compatibility
iOS	iPad 3 and later iPhone 4S and later iPod touch 5 and later
SPARK Element	All models
Android	Android 4.3 and later
Chromebook	Chrome OS (requires PS-3500 Adapter*)
Mac OS X	Models introduced July 2011 or later*
Windows	Windows 7 and later (requires PS-3500 Adapter*)

See Appendix A for more information about the PS-3500 Adapter and Mac OS X models.

Initial Step: Charge the Battery

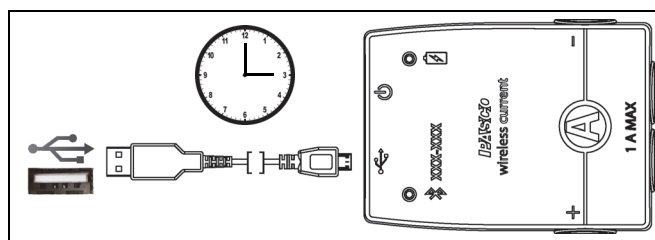

- **Connect the Cable:** Use the Micro USB Cable to connect the micro USB port on the back end of the Wireless Current Sensor to a USB port or USB charger such as the PASCO PS-3501 USB Charging Station. See the diagram.
- Charging begins automatically. The charger circuit inside the sensor turns itself off when the unit is fully charged.
- The battery status LED will shine yellow as the battery is charging, and will shine green when the battery is charged.
- The battery is partially charged at the factory. Initial charging time may be three hours or longer depending on the power source.

ON/OFF Information

To turn the sensor off, press and hold the ON button on the back end of the sensor for a moment until the status LEDs stop blinking. The Wireless Current Sensor puts itself to sleep after several minutes of inactivity if not connected and about one hour of inactivity if connected.

LED Information

The Bluetooth and the Battery Status LEDs operate as follows depending on the type of connection:

For a wireless Bluetooth connection:

Bluetooth LED	Status
Red blink	Ready to pair
Green blink	Connected
Yellow blink	Logging*

Battery LED	Status
Red blink	Low power

For a micro USB cable connection to a USB *port*:

Bluetooth LED	Status
OFF	--
OFF	--
Yellow blink	Logging*

Battery LED	Status
Yellow ON	Charging
Green ON	Charged

For a micro USB cable connection to a USB *charger*:

Bluetooth LED	Status
Red blink	Ready to pair
Green blink	Connected
Yellow blink	Logging*

Battery LED	Status
Yellow ON	Charging
Green ON	Charged

***Logging:** PASCO wireless sensors can either stream live data to a compatible device for “real-time” viewing or log data (save it to the sensor’s memory). After logging, the data can be uploaded to the computing device for display and analysis at a later time. Logging capability supports long-term or remote data collection while not connected to a device.

Check the PASCO Web page at:

www.pasco.com/software

for the latest software version.

Set Up the Hardware

Connecting the Sensor for Measurement

Current is measured through an electric circuit. For that reason, the Wireless Current Sensor is always con-

nected in “series” in a circuit. The sensor is a part of the circuit.

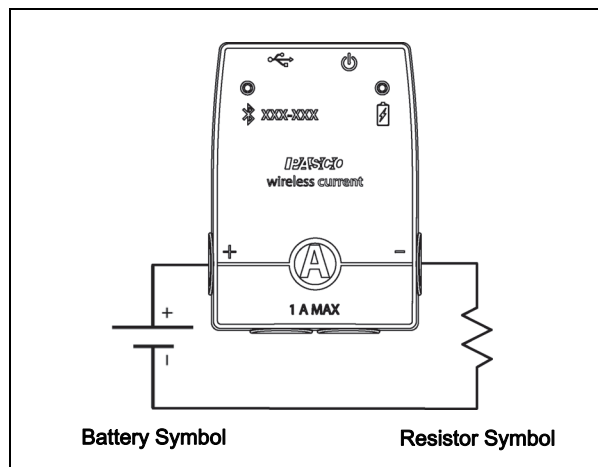

For example, in the diagram, the Wireless Current Sensor is connected in series with a resistor (“load”) that is in series with a battery (“source”). The Wireless Current Sensor measures the current “through” the circuit.

Protection

The Wireless Current Sensor has built-in protection against damaging over-current. If the current exceeds ± 2 amps, the sensor will make a sonic alarm and the status LEDs will both shine red.

If this happens, take the steps necessary to reduce or stop the current through the sensor. For example, disconnect the power source. Analyze the circuit to determine why the over-current happened, and don’t reconnect the power source until the problem is fixed.

Set Up the Software

SPARKvue

Connecting the Wireless Sensor to a Tablet or a Computer via Bluetooth

- For SPARKvue, select the Bluetooth icon () to open the Wireless Devices list. In the Wireless Devices list, the sensors are ordered by proximity to the device.
- Select the correct address that matches the XXX-XXX number found on the sensor.
- Select Done. A list of measurements appears under the sensor in the Home Screen.

Connecting the Wireless Sensor to a Computer with the Micro USB Cable

- Connect the micro end of the included Micro USB Cable into the micro USB port on the end of the sensor.
- Connect the other end of the Micro USB Cable to a USB port on the computer, or into a powered USB hub connected to the computer.

Collect Data

- In the SPARKvue Home Screen, select a measurement from the list under the sensor's name. A graph of the measurement versus time opens.
- In SPARKvue, select the Start button to begin collecting data.

PASCO Capstone

Connecting the Wireless Sensor to a Tablet or a Computer via Bluetooth

- For PASCO Capstone, select Hardware Setup in the Tools palette. The sensors in the list are ordered by proximity to the wireless device.
- Select the sensor with the address that matches the XXX-XXX Device ID number on the sensor.

Connecting the Wireless Sensor to a Computer with the Micro USB Cable

- Connect the micro end of the included Micro USB Cable into the micro USB port on the end of the sensor.
- Connect the other end of the Micro USB Cable to a USB port on the computer, or into a powered USB hub connected to the computer.

Collect Data

- In PASCO Capstone, select a display in the main window or from the Display palette. In the display, use the <Select Measurement> menu to pick a measurement to be shown.
- Select **Record** to begin collecting data.

Troubleshooting the Wireless Current Sensor

- If the Wireless Current Sensor loses Bluetooth connection and will not reconnect, try cycling the ON button. Press and briefly hold the button until the

status LEDs blink in sequence, and then release the button. Start the sensor in the usual way.

- If the sensor stops communicating with the computer software or tablet application, try restarting the software or application.
- If the problem remains, press and hold the ON button for 10 seconds and then release. Start the sensor in the usual way.
- Turn Bluetooth off and then turn it back on. Retry.

About the Battery

The Wireless Current Sensor's battery is partially charged at the factory. If the battery status LED blinks red, use the micro USB cable to connect the sensor to a USB port or a USB charger.

Battery Usage

Battery life is very important to making the sensor simple and always ready to use, so all of the PASCO wireless products are designed for long battery life. For example, the sensor turns itself off after a few minutes of inactivity to conserve battery life.

The battery life between charges for the sensor varies depending on the sampling rate. The battery life ranges between eleven hours for high sample rates to more than 70 hours for low sample rates.

In typical classroom/lab use, this would translate to a battery life between charges ranging from one to four weeks or more, because full-day continuous sampling would be unusual. Even in the most extreme case with a high sample rate, the Current Sensor battery would support a full day of use before needing to recharge.

Maximizing Battery Life

One of the factors that affects battery life is the storage temperature. Therefore, avoid storing the sensor in very cold or very hot environments.

Suggested Experiments

Practically any experiment that uses a Current measurement can be done with the PS-3212 Wireless Current Sensor. See the PASCO Web site at

www.pasco.com/products/lab-manuals

and also select "Training & Resources" at the top of the page for more information about experiments.

Or, enter "Current" into the Search window at

www.pasco.com

Specifications

Item	Value
Ranges	± 0.1 A and ± 1.0 A
Input Resistance	0.1 ohm
Battery	Rechargeable Lithium-Polymer. Expected life of 3 to 4 months on a single charge with normal use.
Connectivity	Bluetooth SMART or USB
Max Wireless Range	30 m (unobstructed)
Max Sample Rate	1000 samples/second via Bluetooth. 100,000 samples/second via USB in burst mod.e

Accessories

The sensor is designed to use a variety of patch cords.

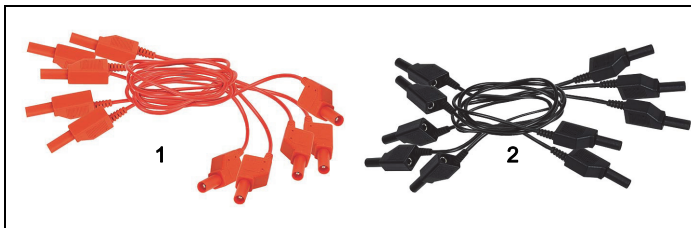

1. Shrouded Red Patch Cords
2. Shrouded Black Patch Cords

- EM-9740 Shrouded Red Patch Cords
- EM-9471 Shrouded Black Patch Cords
- PS-3501 10 Port USB Charging Station
- SE-6484 Ergopedia Electric Circuits and Electronics Teacher Resources
- EM-8622 Basic Electricity Lab

Technical Support

For assistance with any PASCO product, contact PASCO at:

Address: PASCO scientific
10101 Foothills Blvd.
Roseville, CA 95747-7100

Phone: +1 916 462 8384 (worldwide)
8700-772-8700 (U.S.)

Web: www.pasco.com/support

Email: support@pasco.com

The Reference Guide will be updated periodically. For the latest revision of this Reference Guide, visit the PASCO Web site at

www.pasco.com/manuals

and enter the product number, PS-3212, in the text window.

Replacement Parts

For information about possible replacement parts, contact Technical Support:

- USB Cable, Micro-to-USB

Limited Warranty

For a description of the product warranty, see the PASCO catalog. For more information visit www.pasco.com/legal

Copyright

This PASCO scientific *Reference Guide* is copyrighted with all rights reserved. Permission is granted to non-profit educational institutions for reproduction of any part of this manual, providing the reproductions are used only in their laboratories and classrooms, and are not sold for profit. Reproduction under any other circumstances, without the written consent of PASCO scientific, is prohibited. Version 23-07-2016.

Trademarks

PASCO, PASCO scientific, PASCO Capstone, PASPORT, and SPARKvue are trademarks or registered trademarks of PASCO scientific, in the United States and/or in other countries. All other brands, products, or service names are or may be trademarks or service marks of, and are used to identify, products or services of their respective owners. For more information visit www.pasco.com/legal.

FCC Statement

This Class A digital device complies with part 15 of the FCC Rules. Operation is subject to the following two conditions: (1) This device may not cause harmful interference, and (2) this device must accept any interference received, including interference that may cause undesired operation.

CE Statement

This device has been tested and found to comply with the essential requirements and other relevant provisions of the applicable EU Directives.

Product End of Life Disposal Instructions:

This electronic product is subject to disposal and recycling regulations that vary by country and region. It is your responsibility to recycle your electronic equipment per your local environmental laws and regulations to ensure that it will be recycled in a manner that protects human health and the environment. To find out where you can drop off your waste equipment for recycling, please contact your local waste recycle/disposal service, or the place where you purchased the product.

The European Union WEEE (Waste Electronic and Electrical Equipment) symbol (to the right) and on the product or its packaging indicates that this product must not be disposed of in a standard waste container.

**Battery Disposal Instructions:**

Batteries contain chemicals that, if released, may affect the environment and human health. Batteries should be collected separately for recycling, and recycled at a local hazardous material disposal location adhering to your country and local government regulations. To find out where you can drop off your waste battery for recycling, please contact your local waste disposal service, or the product representative.

The Lithium Polymer (Li-Poly) rechargeable battery used in this product is marked with the International symbols to indicate the need for the separate collection and recycling of batteries

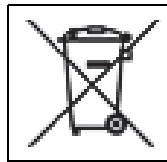

Li-Poly

**Appendix A:  BluetoothSM Compatibility**

Check the PASCO Web page at

www.pasco.com/compatibility

for the latest information on Bluetooth SMART compatibility.

Platform	Bluetooth SMART Compatibility
iOS	iPad 3 and later iPhone 4S and later iPod touch 5 and later
SPARK Element	All models
Android	Android 4.3 and later
Chromebook	Chrome OS (requires PS-3500 Adapter*)
Mac OS X ¹	Models introduced July 2011 or later
Windows	Windows 7 and later (requires PS-3500 Adapter*)

*The PS-3500 USB Bluetooth 4.0 Adapter, when connected to a USB port, allows up to three Bluetooth SMART devices, such as this PASCO wireless device, to connect to Windows computers, Chromebooks, and older Macintosh computers.



Note: The PS-3500 USB Bluetooth 4.0 Adapter is the only adapter we can currently recommend. Many other Bluetooth 4.0 adapters are available but this adapter has a specific design that enables in-app pairing of Bluetooth SMART sensors.

¹To check the Mac computer's Bluetooth compatibility, do the following:

- Click the  (Apple) Menu.
- Select *About This Mac*
- Click the *More Info...* button.
- Click the *System Report...* button.
- Select *Bluetooth* from the sidebar on the left, underneath *Hardware*.
- Scan down the list of information until you find "LMP Version".
- If your Mac is equipped with Bluetooth SMART, the LMP Version will show **0x6**. (Anything lower than **0x6** means an older version of Bluetooth. Your device will need the PS-3500 USB Bluetooth 4.0 Adapter.)

¹The Mac Mini and MacBook Air were updated with Bluetooth SMART support in 2011. The MacBook Pro was updated in 2012. The Mac Pro that debuted in December 2013 has Bluetooth SMART support.

Exception: Before you upgrade to El Capitan (Mac OS X 10.11.x), if you have a Macintosh with LMP version "0x4" that requires the PS-3500 USB Bluetooth 4.0 Adapter, please contact PASCO Technical Support for further instructions.

What is Bluetooth SMART[®]?

Bluetooth SMART (also known as Bluetooth Low Energy or Version 4.0 of the Bluetooth specification) is the latest protocol of the proprietary open wireless technology standard created by telecoms vendor Ericsson in 1994. It is the power- and application-friendly version of Bluetooth that was built for the Internet of Things (IoT).