

# Wireless pH Sensor

PS-3204

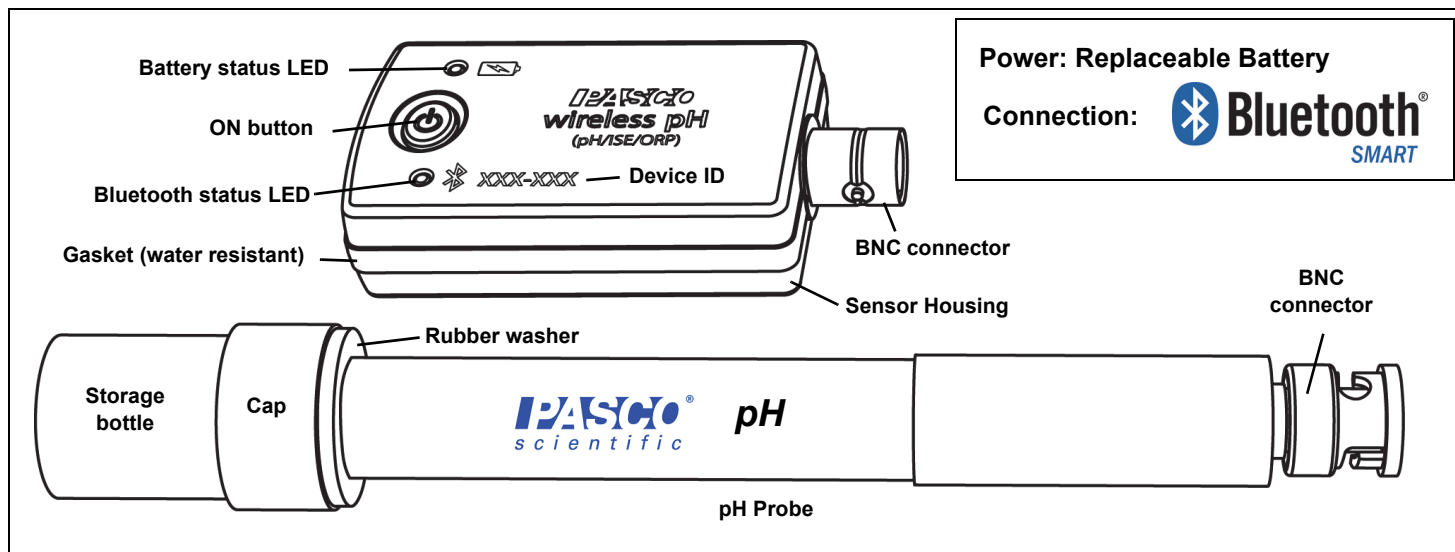

## Hardware

Included Equipment	Part Number
Wireless pH Sensor	PS-3204
pH Probe	

## Introduction

The Wireless pH Sensor measures the pH of a solution within a range between 0 and 14 pH. The pH of a solution is a numeric scale used to specify the acidity or alkalinity of an aqueous solution. The pH of pure water is 7, the pH of an acidic solution is generally between 7 and 0, and the pH of a basic solution is generally between 7 and 14. The pH measurement is transmitted wirelessly through Bluetooth<sup>SM</sup> and recorded and displayed by the PASCO software on a connected wireless device such as a tablet or computer. The Wireless pH Sensor is powered by a replaceable three volt coin cell battery (included) and is well-suited for continuous recording and discrete measurements. The sensor is designed to optimize the battery usage time.

Since each sensor has a unique Device ID number, more than one can be connected to a computer or tablet at the same time.

The pH Sensor can also be used with alternative probes, such as Ion Selective Electrodes (ISE) and the

Oxidation-Reduction Potent (ORP) Probe. (See Alternative Probes, page 4.)

The pH sensor housing is water resistant (depth of 1 meter in water for 30 minutes). However, *immersing it in water or other fluids may cause a loss of wireless connection.* Put only the end of the included pH Probe into the substance being measured.

## ON/OFF Information

To turn the sensor on, press and hold the ON button temporarily until the status LEDs start blinking. To turn the sensor off, press and hold the ON button for a moment until the status LEDs stop blinking. The sensor puts itself to sleep after a period of about one hour of inactivity if connected, and several minutes of inactivity if not connected.

### Data Collection Software

PASCO Capstone

SPARKvue



- Mac OS X
- Windows
- Mac OS X
- Windows
- iOS
- Android
- Chromebook

See the PASCO web site at [www.pasco.com/software](http://www.pasco.com/software) for help in selecting the right PASCO software and to check the latest versions.

### Bluetooth<sup>SM</sup> Compatibility

Platform	Bluetooth SMART Compatibility
iOS	iPad 3 and later iPhone 4S and later iPod touch 5 and later
SPARK Element	All models
Android	Android 4.3 and later
Chromebook	Chrome OS (requires PS-3500 Adapter*)
Mac OS X	Models introduced July 2011 or later*
Windows	Windows 7 and later (requires PS-3500 Adapter*)

See Appendix A for more information about the PS-3500 Adapter and Mac OS X models.

### LED Information

The Bluetooth connection LED (light-emitting diode) and the battery status LED operate as follows:

Bluetooth LED	Status
Red blink	Ready to pair
Green blink	Connected
Yellow blink	Logging*

Battery LED	Status
Red blink	Low power

**\*Logging:** PASCO wireless sensors can either stream live data to a compatible device or log data (save it to the sensor's memory). The data can then be uploaded to the device for display and analysis at a later time. Logging capability supports long-term or remote data collection while not connected to the device.

Note: Versions of SPARKvue and PASCO Capstone available in 2016 will support logging. Check the PASCO Web page at:

[www.pasco.com/software](http://www.pasco.com/software)

for the latest software version.

## Set-up

### Connecting the pH Probe

Hold the Wireless pH Sensor in one hand and the pH Probe in the other. Align the tabs on the sensor's BNC connector with the slots on the BNC connector at the end of the pH Probe. Push the probe's BNC connector onto the sensor's BNC connector. Twist the probe's BNC connector clockwise (left-to-right) about one-quarter turn to lock it in place.

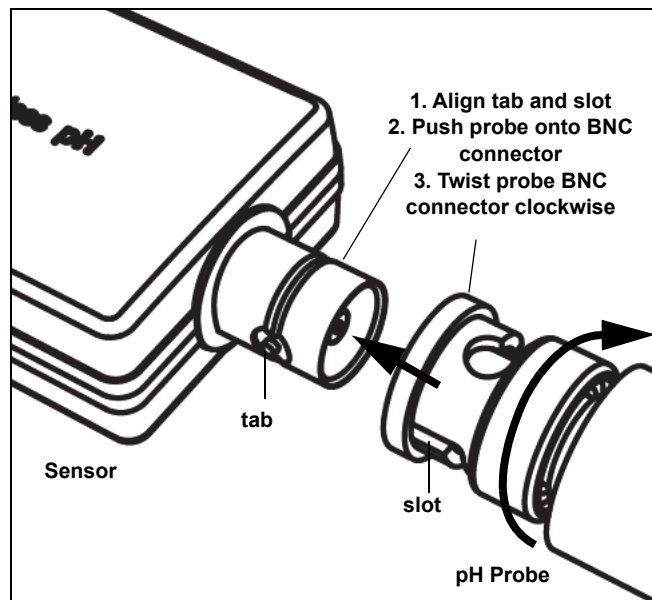

To remove the pH Probe from the Wireless pH Sensor, reverse the process. NOTE: When removing the probe, it may help to push the pH Probe onto the pH Sensor connector slightly before twisting the BNC connector counter-clockwise to release the probe.

### Removing the Storage Bottle

1. Hold the pH Probe vertically so that the solution will not spill out of the bottle.
2. Unscrew the plastic cap and remove the bottle. Keep the storage solution for later use.
3. Push the bottle cap and the rubber washer up the pH Probe shaft to keep them out of the way.

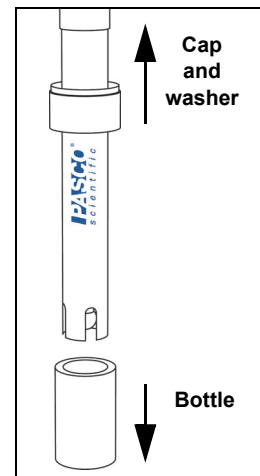

### Connecting the Sensor to a Wireless Device

## or a Computer via Bluetooth

### SPARKvue

#### Software Help

See the SPARKvue Help for information about collecting, displaying, and analyzing data.

- In SPARKvue, select the HELP button (  ) in any screen, including the Home Screen.

#### Connect the Sensor

- In SPARKvue, select the Bluetooth icon. In the **Wireless Devices** list that opens, select the desired sensor that matches the XXX-XXX Device ID number on the sensor. Select Done.



#### Collect Data

- In SPARKvue, select a measurement from the list under the sensor in the Home Screen. A graph of the measurement versus time opens.
- Select the Start button to begin collecting data.

### PASCO Capstone

#### Software Help

See the PASCO Capstone Help for information about collecting, displaying, and analyzing data.

- In PASCO Capstone, select **PASCO Capstone Help** from the **Help** menu, or press **F1**.

#### Connect the Sensor

- In PASCO Capstone, click **Hardware Setup** in the **Tools** palette to confirm that the sensor is recognized. Select the desired sensor in the **Hardware Setup** window that matches the XXX-XXX Device ID number on the sensor. Close the **Hardware Setup** window.

#### Collect Data

- In PASCO Capstone, select a display in the main window. In the display, use the **<Select Measurement>** menu(s) to set up the desired measurement in the display.
- Select **Record** to begin collecting data.

### Collecting Data

- Rinse the end of the pH Probe with distilled water.

- Immerse the end of the pH Probe in the solution to be measured. The bulb-shaped glass membrane should be entirely immersed.
- Press or click start or record to begin recording data.
- Wait for the reading to stabilize.
- Rinse the end of the pH Probe again before placing it in another solution.

### Calibration

Calibration is not always necessary, especially if you are measuring a change in pH rather than absolute pH values. However, the pH Sensor can be calibrated. For detailed theory of calibration, see Appendix B at the end of the document.

### Battery Usage

The Wireless pH Sensor includes a 3 V coin cell battery (CR2032). Battery life is very important in making the sensor simple and always ready to use, so all of the PASCO wireless products are designed for long battery life. For example, the sensor turns itself off after a short time of inactivity.

We expect more than one year of battery life, but the actual amount depends on factors such as the data collection sampling rate.

### Sensor Storage

If the sensor will be stored for many months, we recommend that you remove the battery to avoid damaging the sensor in case of a battery leak.

### Battery Removal and Replacement

If the sensor's battery status LED blinks red, the battery may need to be replaced. Replacing the small, disk-shaped battery involves removing the Battery Compartment Door on the bottom of the sensor, removing the old battery, installing a new battery of the same type, and replacing the Battery Compartment Door. The procedure needs a coin and a CR2032 three volt battery. (NOTE: This battery is commonly available in electronic and commercial stores.)

### Remove the Battery Compartment Door

Hold the sensor bottom-side up. Use a coin in the slot to turn the Battery Compartment Door counterclockwise (left-to-right) until the indicator on the door is aligned with the second mark on the sensor.

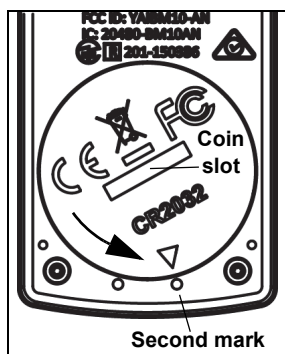

Turn the sensor bottom-side down so that the Battery Compartment Door can drop into the palm of your hand. Make sure that the battery door gasket stays on the door. The gasket is an “O-ring” that is held in place by the tabs on the door. Please do not touch the inside of the battery compartment.

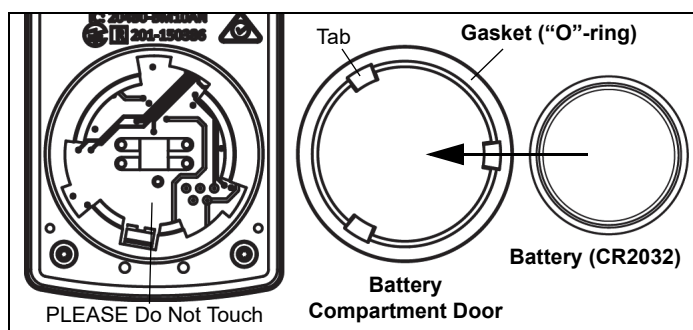

Remove the used battery from the Battery Compartment Door and replace it with a new identical type battery. *Note that the battery is held in place by the small tabs on the door.* The side of the battery with the “+” on it should be against the door.

### Replace the Battery Compartment Door

Put the Battery Compartment Door with the new battery back onto the sensor. Align the indicator on the door with the second mark, and use the coin in the slot to turn the door clockwise (right-to-left) until the indicator is aligned with the first mark on the sensor.



(See “Battery Disposal Instructions” under Technical Support.)

### Related Item

- Coin-cell Battery Replacement Pack (10 pack) - PS-3504

### Troubleshooting the Wireless pH Sensor

- If the Wireless pH Sensor loses Bluetooth connection and will not reconnect, try cycling the ON button. Press

and briefly **hold** the button until the status LEDs blink, and then release the button

- If the sensor stops communicating with the computer software or tablet application, try restarting the software or application. If the problem remains, press and hold the ON button for ten seconds and then release the button. Turn on the sensor in the usual way.
- Turn Bluetooth off and then turn it back on. Retry.

### pH Probe Maintenance

#### pH Probe Storage

For a storage period of a few weeks or less, rinse the end of the pH Probe with distilled water and put the storage bottle back onto the end of the probe.

- NOTE:** To make more storage solution, combine equal parts of 4 M potassium chloride (KCl) and a pH 4 buffer solution, with a few drops of pH buffer preservative.

You may keep the pH Probe in the storage solution indefinitely. After a long period of storage, the pH Probe may become dry. If so, the pH Probe can be restored by re-hydrating the glass membrane (see below).

#### Restoring the pH Probe

Use the following procedure to improve the performance of a slow pH Probe or to rehydrate the glass membrane.

- Clean the pH Probe using one or more of these methods.
  - If the pH Probe is contaminated with proteins, soak the probe in a solution of 1% pepsin in 0.1 M hydrochloric acid (HCl).
  - If the pH Probe is contaminated with inorganic deposits, rinse the probe with 0.1 M ethylene dintric tetra-acidic acid (EDTA) tetrasodium solution.
  - If the pH Probe is contaminated with oil or grease, wash the probe in a mild detergent or solvent known to be effective for oil or grease.
  - If the pH Probe is not responding quickly, soak the probe alternately in 12 M sodium hydroxide (NaOH) and 1 M hydrochloric acid (HCl). Leave the probe in each solution for one minute. Rinse completely between soakings and end with hydrochloric acid.
- Soak the pH Probe in 0.1 hydrochloric acid for 30 minutes.
- Soak the pH Probe in a pH 7 buffer solution for 10 minutes.

If the restoring procedure fails to improve the response of the pH Probe, replace the probe.

**Related Items**

- pH Buffer Capsule Kit (SC-2321)
- PASPORT High Accuracy Drop Counter (PS-2117)



The PASPORT High Accuracy Drop Counter is designed to measure drops of a solution that are added to another solution, such as during a titration experiment.

**Alternative Electrodes**

The Wireless pH Sensor works with several alternative electrodes available from PASCO:

- Oxidation Reduction Potential (ORP) Probe<sup>1</sup>
- Ammonium Ion Selective Electrode (ISE)<sup>2</sup>
- Carbon Dioxide Ion Selective Electrode
- Calcium Ion Selective Electrode
- Chloride Ion Selective Electrode
- Potassium Ion Selective Electrode
- Nitrate Ion Selective Electrode



<sup>1</sup>**Note:** The Oxidation Reduction Potential Probe is used to monitor solutions during oxidation-reduction titrations, perform water quality studies, and measure the effects of water chlorination.

<sup>2</sup>**Caution:** Advanced Chemistry Procedures Required

The PASCO Ion Selective Electrodes are industrial quality probes that give excellent results when properly used. Operation of these electrodes assumes training in the safe handling of flammable, caustic and corrosive chemicals and a working knowledge of serial dilution and calibration procedures.

**Suggested Experiments**

Practically any experiment that uses a pH measurement can be done with the PS-3204 Wireless pH Sensor. See the PASCO Web site at

[www.pasco.com/products/lab-manuals](http://www.pasco.com/products/lab-manuals)

for more information about experiments

**Specifications**

pH Sensor	
<b>pH Range</b>	0 to 14
<b>Accuracy</b>	±0.1 after calibration
<b>Resolution</b>	0.02
pH Probe	
<b>Type</b>	Gel-filled Ag-AgCl combination electrode
<b>Connector</b>	BNC

**Technical Support**

For assistance with any PASCO product, contact PASCO at:

Address: PASCO scientific  
10101 Foothills Blvd.  
Roseville, CA 95747-7100

Phone: +1 916 462 8384 (worldwide)  
800-772-8700 (U.S.)

Web: [www.pasco.com](http://www.pasco.com)

Email: [support@pasco.com](mailto:support@pasco.com)

The Reference Guide will be updated periodically. For the latest revision of this Reference Guide, visit the PASCO Web site at

[www.pasco.com/manuals](http://www.pasco.com/manuals)

and enter the product number, PS-3204, in the text window.

**Limited Warranty**

For a description of the product warranty, see the PASCO catalog. For more information visit [www.pasco.com/legal](http://www.pasco.com/legal).

**Copyright**

This PASCO scientific document is copyrighted with all rights reserved. Permission is granted to non-profit educational institutions for reproduction of any part of this manual, providing the reproductions are used only in their laboratories and classrooms, and are not sold for profit. Reproduction under any other circumstances, without the written consent of PASCO scientific, is prohibited. Revised 11/17.

**Trademarks**

PASCO, PASCO scientific, PASCO Capstone, PASPORT, and SPARKvue are trademarks or registered trademarks of PASCO scientific, in the United States and/or in other countries. All other brands, products, or service names are or may be trademarks or service marks of, and are used to identify, products or services of their respective owners. For more information visit [www.pasco.com/legal](http://www.pasco.com/legal).

**FCC Statement**

This Class A digital device complies with part 15 of the FCC Rules. Operation is subject to the following two conditions: (1) This device may not cause harmful interference, and (2) this device must accept any interference received, including interference that may cause undesired operation.

**CE Statement**

This device has been tested and found to comply with the essential requirements and other relevant provisions of the applicable EU Directives.

**Product End of Life Disposal Instructions:**

This electronic product is subject to disposal and recycling regulations that vary by country and region. It is your responsibility to recycle your electronic equipment per your local environmental laws and regulations to ensure that it will be recycled in a manner that protects human health and the environment. To find out where you can drop off your waste equipment for recycling, please contact your local waste recycle/disposal service, or the place where you purchased the product.

The European Union WEEE (Waste Electronic and Electrical Equipment) symbol (to the right) and on the product or its packaging indicates that this product **must not** be disposed of in a standard waste container.

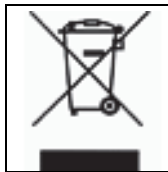
**Battery Disposal Instructions:**

Batteries contain chemicals that, if released, may affect the environment and human health. Batteries should be collected separately for recycling, and recycled at a local hazardous material disposal location adhering to your country and local government regulations. To find out where you can drop off your waste battery for recycling, please contact your local waste disposal service, or the product representative.

The battery used in this product is marked with the International symbols to indicate the need for the separate collection and recycling of batteries.

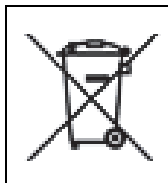

## Appendix A: Bluetooth<sup>SM</sup> Compatibility

Check the PASCO Web page at

[www.pasco.com/compatibility](http://www.pasco.com/compatibility)

for the latest information on Bluetooth SMART compatibility.

Platform	Bluetooth SMART Compatibility
iOS	iPad 3 and later iPhone 4S and later iPod touch 5 and later
SPARK Element	All models
Android	Android 4.3 and later
Chromebook	Chrome OS (requires PS-3500 Adapter*)
Mac OS X <sup>1</sup>	Models introduced July 2011 or later
Windows	Windows 7 and later (requires PS-3500 Adapter*)

\*The PS-3500 USB Bluetooth 4.0 Adapter, when connected to a USB port, allows up to three Bluetooth SMART devices, such as this PASCO wireless device, to connect to Windows computers, Chromebooks, and older Macintosh computers.



Note: The PS-3500 USB Bluetooth 4.0 Adapter is the only adapter we can currently recommend. Many other Bluetooth 4.0 adapters are available but this adapter has a specific design that enables in-app pairing of Bluetooth SMART sensors.

<sup>1</sup>To check the Mac computer's Bluetooth compatibility, do the following:

- Click the  (Apple) Menu.
- Select *About This Mac*
- Click the *More Info...* button.
- Click the *System Report...* button.
- Select *Bluetooth* from the sidebar on the left, underneath *Hardware*.
- Scan down the list of information until you find "LMP Version".
- If your Mac is equipped with Bluetooth SMART, the LMP Version will show **0x6**. (Anything lower than **0x6** means an older version of Bluetooth. Your device will need the PS-3500 USB Bluetooth 4.0 Adapter.)

<sup>1</sup>The Mac Mini and MacBook Air were updated with Bluetooth SMART support in 2011. The MacBook Pro was

updated in 2012. The Mac Pro that debuted in December 2013 has Bluetooth SMART support.

Exception: Before *you upgrade to El Capitan* (Mac OS X 10.11.x), if you have a Macintosh with LMP version "0x4" that requires the PS-3500 USB Bluetooth 4.0 Adapter, please contact PASCO Technical Support for further instructions.

### What is Bluetooth SMART<sup>®</sup>?

Bluetooth SMART (also known as Bluetooth Low Energy or Version 4.0 of the Bluetooth specification) is the latest protocol of the proprietary open wireless technology standard created by telecoms vendor Ericsson in 1994. It is the power- and application-friendly version of Bluetooth that was built for the Internet of Things (IoT).

## Appendix B: Calibration

### Prepare for Calibration

Calibration will need distilled water, two different pH buffer solutions, and containers for the water and buffer solutions. The sensor will need to be “paired” with a tablet or computer, and the data collection software should be running.

- The **pH Buffer Capsule Kit (SC-2321)** from PASCO includes three vials, each with ten capsules of pH 4.0, pH 7.0, and pH 10.0, and a bottle of preservative solution which contains a pH indicator and will color each buffer solution for easy identification.
- Each capsule can make 100 milliliters (ml) of buffer solution.
- Containers such as 100 ml and 1000 ml beakers are available from PASCO.
- Make two buffer solutions with pH values that “bracket” the pH values to be measured. For this example, make one with pH 4 and the other with pH 7. The calibration buffer solutions should be at the same temperature as the solutions that will be measured.

### Using SPARKvue Software for Calibration

NOTE: Check the on line Help System in SPARKvue for the most up-to-date information.

1. Click (or press) the Experiment Tools button (.
- The **Experiment Tools** screen opens.
2. Click **Calibrate Sensor**.
- The **Calibrate Sensor: Select Measurement** screen opens.
3. Click the Sensor box and click the sensor to be calibrated.
4. Click the **Calibration Type** box and click a calibration type. (For this example, click “**2-point**”.)
5. Click **Next**.
- The **Calibrate Sensor Enter Values** screen opens.
6. Rinse the end of the pH Probe in distilled water and then put the pH Probe into a pH 4 buffer solution.
7. Under **Calibration Point 1**, click the **Standard Value** box and enter the known value (4.00 in this example).
8. Under **Calibration Point 1**, click **Read From Sensor**.

- The value measured by the sensor is transferred to the **Sensor Value** box.
9. Take the probe out of the first buffer solution and rinse the end of the probe with distilled water. Dry the probe and then put the pH Probe into the pH 7 buffer solution.
  10. Under **Calibration Point 2**, click the **Standard Value** box and enter the pH buffer’s known value (7.00 in this example).
  11. Under **Calibration Point 2**, click the **Read From Sensor** box.
  - The second value measured by the sensor is transferred to the **Sensor Value** box.
  12. Click OK.

### Using PASCO Capstone for Calibration

NOTE: Check the on line Help System in PASCO Capstone for the most up-to-date information.

1. Click **Calibration** () in the **Tools** Palette.
2. Choose the probe you would like to calibrate now: **pH Measurement**.
3. Click **Next**.
4. Choose the type of calibration you would like to perform: **Two Standards (2 point)**.
5. Click **Next**.
6. Enter the first known pH buffer value (4.00 in this example) in the **Standard Value** text box.
7. Rinse and dry the pH Probe
8. Place the pH Probe in the pH 4 buffer solution and stir.
9. When the **Current Value** stabilizes, click **Set Current Value to Standard Value**.
10. Click **Next**.
11. Enter the second known pH buffer value (7.00 in this example) in the **Standard Value** text box.
12. Remove the probe from the first buffer solution and rinse and dry the end of the probe
13. Place the probe in the second buffer solution and stir.
14. When the **Current Value** stabilizes, click **Set Current Value to Standard Value**.



15. Click **Next**.

16. Click **Finish**. Rinse and dry the probe before using it for data measurement.

### Theory of Calibration

One of the functions of the PASCO Data Collection Software is to take the stream of raw data from a sensor and transform it into the calibrated data that you see in the Graph, Table, and other displays. If you do not calibrate a sensor yourself, the software uses a default calibration that is loaded when the sensor is connected.

You can think of the software as taking in raw data and outputting calibrated data. When you perform a calibration, the software redefines the linear equation that transforms the raw input data into the calibrated output data. The linear function is of the form:

$$\text{Raw Input} = \text{Slope} \times \text{Calibrated Output} + \text{Offset}$$

Or:

$$\text{Calibrated Output} = (\text{Raw Input} - \text{Offset}) / \text{Slope}$$

The function can be represented graphically as a line.

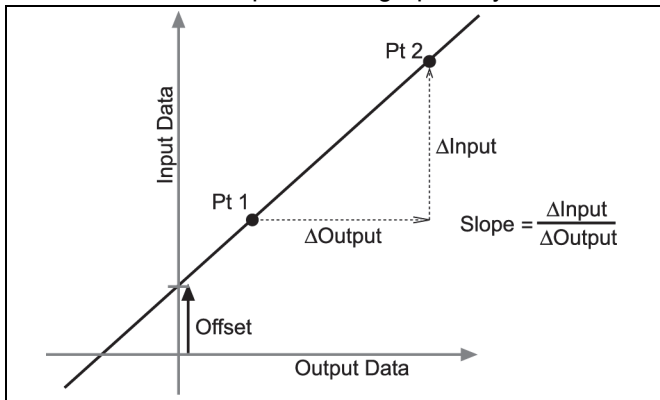

Two points, Pt 1 and Pt 2, define the line. In the two-point calibration procedure, each point is reset by associating a known standard value (for instance, the pH of a buffer solution) with a raw input measurement that the sensor sends to the GLX when it is in that standard. In a one-point calibration, only one of the points is reset by the user.

### Types of Calibration

There are three types of calibration: two-point, one-point slope, and one-point offset. Any of these calibrations can be performed on a single sensor, or simultaneously on multiple similar sensors; however, for any given sensor, the software will automatically select the most typical calibration type as the default setting.

### Two-Point

In a two-point calibration, you reset two points to define a new line. This type of calibration affects both the slope and the offset.

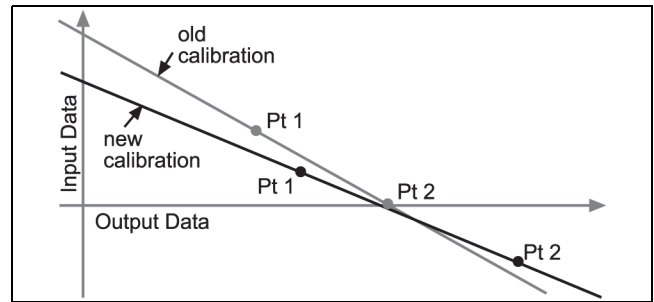

### One-Point Slope

In a one-point slope calibration, you reset only one point. The slope of the line changes so that the line intersects the new point, while the offset (or Y-intercept) does not change.

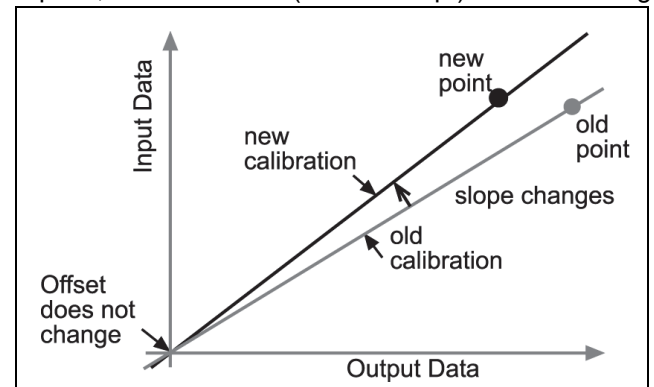

### One-Point Offset

In a one-point offset calibration, you reset only one point. The line shifts so that it intersects the new point, but its slope does not change.

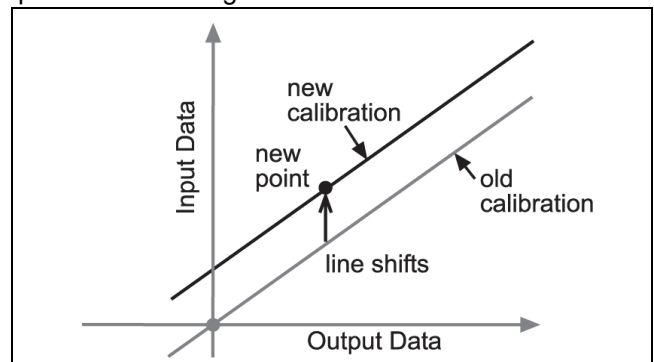

Offset calibration is usually used to make one sensor agree with another sensor. Due to normal variation among probes, a second probe might read consistently higher than the first probe. Normally this difference would be insignificant; however, an offset calibration can be used to bring the sensors into closer alignment.