

Wireless Smart Cart

ME-1240 (Red) / ME-1241 (Blue)

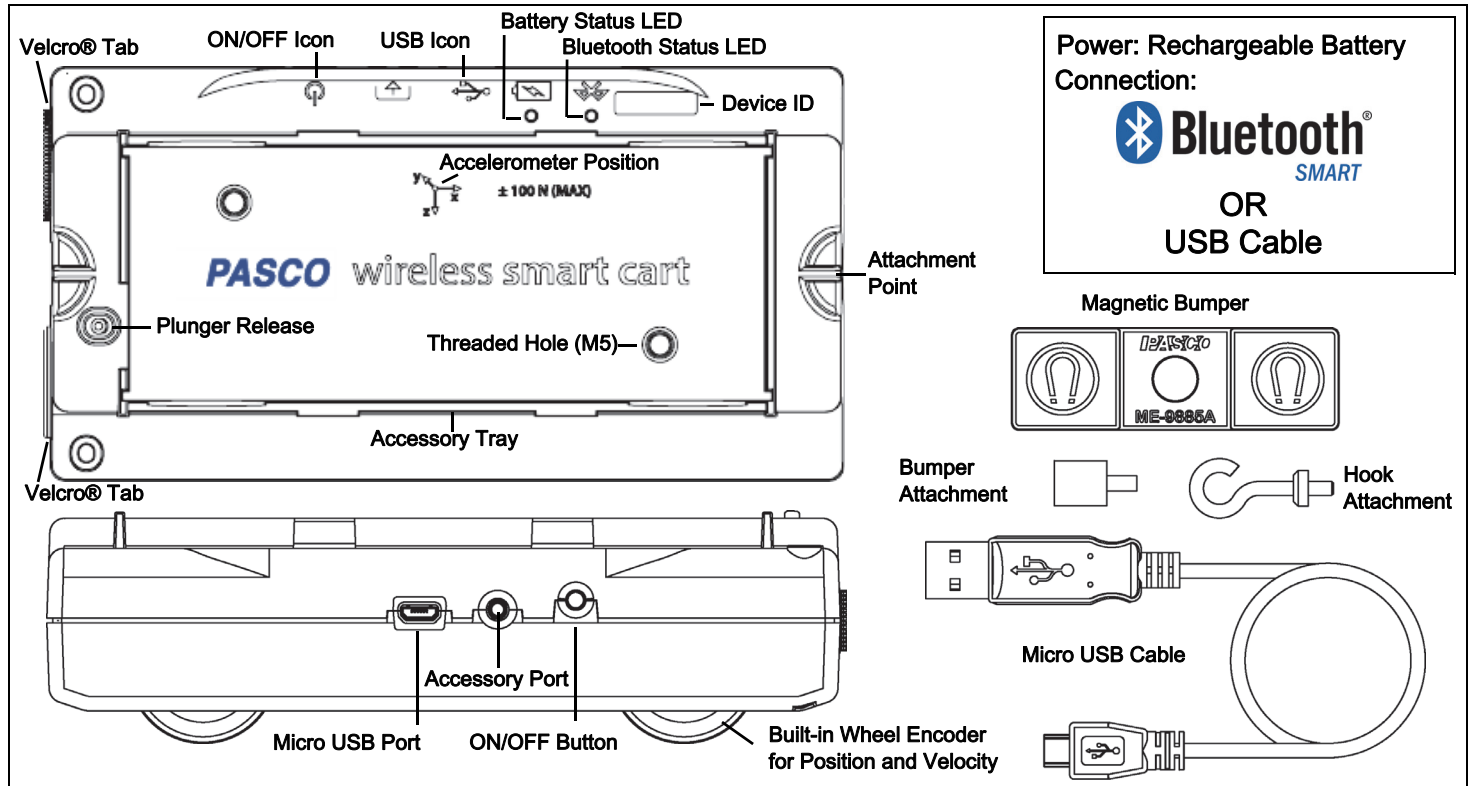

Hardware

Included Equipment	Part Number
Wireless Smart Cart	ME-1240 or ME-1241
Magnetic Bumper	ME-9885A
Hook Attachment	
Bumper Attachment	
Micro USB Cable (1 meter)	

Required

Software	For Information
PASCO Data Collection Software	www.pasco.com

See the PASCO Web page at

www.pasco.com/software

for help in selecting the right PASCO software and to check the latest versions.

Introduction

The Wireless Smart Cart is a combination wireless *and* USB device that connects to a computer or tablet through Bluetooth® (version 4.2 or later), or to a computer or USB charger with a micro USB cable (included). The Smart Cart has a durable ABS body, a three-position plunger, and nearly frictionless wheels. It includes built-in sensors that measure force, position, velocity, and three degrees of freedom in acceleration. The Smart Cart also includes a gyroscope-type sensing element that can measure rotational motion. The Smart Cart can make its measurements on or off a dynamics track and transmit them wirelessly. For easy identification, the Smart Cart is available in red or blue.

The accessory tray on the top of the Smart Cart can hold any of the accessories designed for a PASCO cart. The Smart Cart dimensions are the same as other PASCO carts and can be used with any PASCO track. The Smart Cart can be stacked with any PASCO cart and its mass is approximately 0.250 kilograms (about 250 grams). It has attachment points on the top and bottom of both ends, and Velcro® tabs for inelastic collisions on one end. The Magnetic Bumper, Bumper Attachment, and Hook Attachment fit into the threaded hole in the end of the Smart Cart opposite to the tabs.

The built-in sensors measure force in the range between -100 newtons (N) and +100 N, acceleration in the range between -16g and +16g ($g = \pm 9.8 \text{ m/s}^2$), and angular rotation rate up to ± 245 degrees per second (dps). It measures force as a push or pull along its X axis and measures acceleration in three dimensions (X, Y, and Z). The PASCO Data Collection Software can also show the resultant acceleration. The encoder wheels on the Smart Cart measure motion to a maximum of 3.0 meters per second with a resolution of 0.2 millimeters (mm). The positive direction of motion is the same as the X-axis in the graphic that represents the acceleration sensor's position

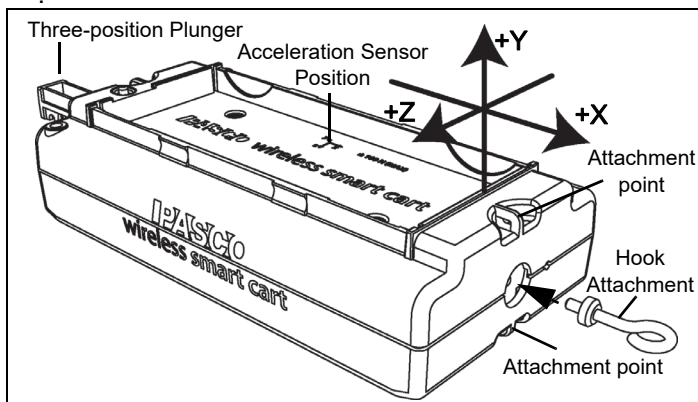

The Smart Cart is designed to optimize the battery usage time. Since each Smart Cart has a unique Device ID number, more than one can be connected to a computer or tablet at the same time.

The Smart Cart is designed by PASCO in California and assembled in China.

Data Collection Software

PASCO Capstone



- Mac OS X
- Windows

SPARKvue



- Mac OS X
- Windows
- iOS
- Android
- Chromebook

See the PASCO Web page at

www.pasco.com/software

for help in selecting the right PASCO software and to check the latest versions.

NEW: The Wireless Smart Cart can now be used with the free PASCO program MatchGraph 2.0 that can be downloaded at

www.pasco.com/matchgraph.

Software Help

See the SPARKvue Help or PASCO Capstone Help for information about collecting, displaying, and analyzing data.

- In SPARKvue, select the **HELP** button (?) in any screen including the Home Screen.
- In PASCO Capstone, select **PASCO Capstone Help** from the **Help** menu, or press **F1**.

Bluetooth® Compatibility

Check the PASCO Web page at

www.pasco.com/wireless

for the latest information on Bluetooth SMART compatibility.

Platform	Bluetooth SMART Compatibility
iOS	iPad 3 and later iPhone 4S and later iPod touch 5 and later
SPARK Element	All models
Android	Android 4.3 and later
Chromebook	Chrome OS (requires PS-3500 Adapter*)
Mac OS X	Models introduced July 2011 or later*
Windows	Windows 7 and later (requires PS-3500 Adapter*)

*See Appendix A for more information about the PS-3500 Adapter and Mac OS X models.

Initial Step: Charge the Battery

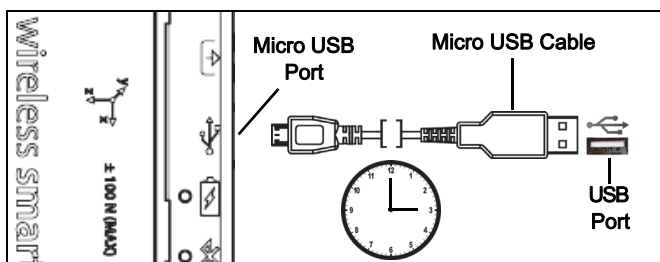

- Connect the Cable:** Use the Micro USB Cable to connect the micro USB port on the Wireless Smart Cart to a USB port or USB charger such as the PASCO PS-3501 USB Charging Station. Charging begins automatically. The charger circuit inside the Smart Cart turns itself off when the unit is fully charged. The battery status LED will shine yellow as the battery is charging, and will shine green when the battery is charged. The battery is partially charged at the factory. Initial charging time may be three hours or longer depending on the power source and the condition of the battery.

ON/OFF Information

To turn the Smart Cart on, press and hold the ON button for a moment until a status LED starts blinking. To turn the Smart Cart off, press and hold the ON button for a moment until the status LEDs stop blinking. The Wireless Smart Cart puts itself to sleep after several minutes of inactivity if not connected and a much longer time of inactivity if connected.

LED Information

The Bluetooth and the Battery Status LEDs operate as follows depending on the type of connection:

For a wireless Bluetooth connection:

Bluetooth LED	Status
Red blink	Ready to pair
Green blink	Connected

Battery LED	Status
Red blink	Low power

For a micro USB cable connection to a USB port:

Bluetooth LED	Status
OFF	--
OFF	--

Battery LED	Status
Yellow ON	Charging
Green ON	Charged

For a micro USB cable connection to a USB charger:

Bluetooth LED	Status
Red blink	Ready to pair
Green blink	Connected

Battery LED	Status
Yellow ON	Charging
Green ON	Charged

Check the PASCO Web page at:

www.pasco.com/software

for help in selecting the right software and to check the latest software version.

Set Up the Software

SPARKvue

See the SPARKvue Help for information about setting up the software:

- In SPARKvue, select the HELP button (?) in any screen, such as the Home Screen.

Connecting the Wireless Smart Cart to a Tablet or a Computer via Bluetooth

- For SPARKvue, select the Bluetooth icon () to open the **Wireless Devices** list. In the **Wireless Devices** list, the devices are ordered by proximity to the tablet or computer. Select the Smart Cart that matches the XXX-XXX number found on the Smart Cart. Select **Done**. A list of measurements appears under the Smart Cart in the **Home Screen**.

Connecting the Wireless Smart Cart to a Computer with the Micro USB Cable

- Connect the micro end of the included Micro USB Cable into the micro USB port on the end of the Smart Cart. Connect the other end of the Micro USB Cable to a USB port on the computer, or into a powered USB hub connected to the computer.

Zero (Tare) the Smart Cart

At the beginning of an experiment, the measurement from the built-in force and acceleration sensors may not be zero when the force or acceleration is actually zero. This is a normal behavior that is corrected when you zero (or tare) the sensor using the PASCO Data Collection Software. See Appendix B for information about setting the built-in sensors to zero.

Collect Data

- In the SPARKvue **Home Screen**, select a measurement from the list under the sensor's name. A graph of the measurement versus time opens.
- In SPARKvue, select the **Start** button () to begin collecting data.

PASCO Capstone

See the PASCO Capstone Help for information about setting up the software:

- In PASCO Capstone, select **PASCO Capstone Help** from the **Help** menu, or press **F1**.

Connecting the Wireless Smart Cart to a Tablet or a Computer via Bluetooth

- For PASCO Capstone, select **Hardware Setup** in the Tools palette. The devices in the list are ordered by proximity to the tablet or computer. Select the Smart Cart with the address that matches the XXX-XXX Device ID number on the Smart Cart.

Connecting the Wireless Smart Cart to a Computer with the Micro USB Cable

- Connect the micro end of the included Micro USB Cable into the micro USB port on the side of the Smart Cart. Connect the other end of the Micro USB Cable to a USB port on the computer, or into a powered USB hub connected to the computer.

Zero (Tare) the Force Sensor

At the beginning of an experiment, the measurement from the built-in force and acceleration sensors may not be zero when the force or acceleration is actually zero. This is a normal behavior that is corrected when you zero (or tare) the sensor using the PASCO Data Collection Software. See Appendix B for information about how to set the built-in sensors to zero.

Collect Data

- In PASCO Capstone, select a display in the main window or from the **Display** palette. In the display, use the **<Select Measurement>** menu to pick a measurement to be shown.
- Select **Record** to begin collecting data.

MatchGraph!

- Download and install the MatchGraph! software program. Turn on the Smart Cart.
- Start the MatchGraph! program.



A "Sensor Not Found" window opens.

- In the "A Sensor Not Found" window, select "Choose Wireless Interface".

The Smart Cart and its ID number will appear under "Wireless Interfaces" in the "Select Wireless Interface" window. (If there are more than one Smart Cart, the first one of the list is the closest to your computing device.)

- Click or tap the first Smart Cart in the list to close the window.
- In the MatchGraph! program, click or tap the "Record" button to begin.

Troubleshooting the Wireless Smart Cart

- If the Wireless Smart Cart loses Bluetooth connection and will not reconnect, try cycling the ON button. Press and briefly **hold** the button until the status LEDs blink in sequence, and then release the button. Start the Smart Cart in the usual way.
- If the Smart Cart stops communicating with the computer software or tablet application, try restarting the software or application. If the problem remains, press and hold the ON button for 10 seconds and then release. Start the Smart Cart in the usual way.
- Turn Bluetooth off and then turn it back on. Retry.

Set Up the Hardware

Connecting Bumper and Hook Attachments

Screw the bumper or hook attachment into the threaded hole on the front end of the Smart Cart as shown.

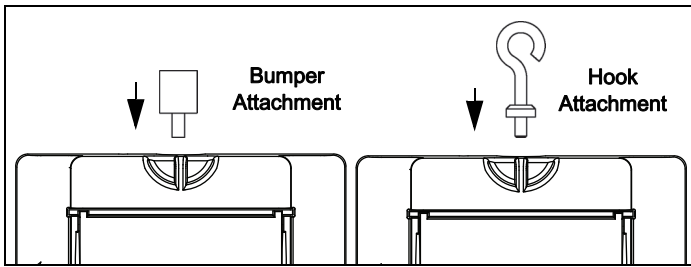

The Magnetic Bumper has a metal post that fits in the small hole to the side of the threaded hole in the front end of the Smart Cart. The post ensures that the Magnetic Bumper is mounted in the correct orientation.

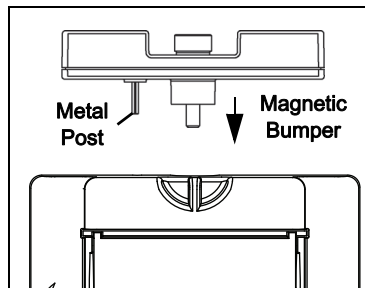

Direction of Acceleration Sensitivity

The acceleration sensing unit inside the Smart Cart is oriented so that the lines of greatest sensitivity follow the three X-Y-Z arrows indicating the direction of acceleration.

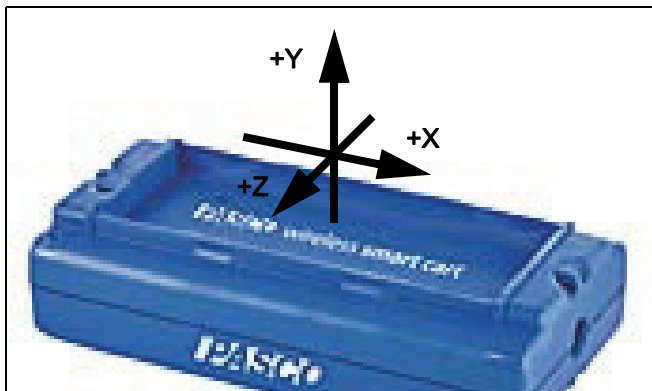

In this orientation, the X-axis direction is 'along' the long axis of the Smart Cart, the Y-axis direction is 'perpendicular' relative to the top of the Smart Cart. The Z-axis direction is 'perpendicular' to the long axis of the Smart Cart and parallel relative to the top of the cart.

Test the Smart Cart's Output Using Earth's Gravity

Start the PASCO Data Collection Software. If the Smart Cart is held so that the X-axis on the top of the Smart Cart is vertical and pointing upward, the Acceleration X-axis reading is +1.0 g. If the Smart Cart is turned so the X-axis is vertical but pointing downward, the Acceleration X-axis reading is -1.0 g (where "g" represents the acceleration due to gravity).

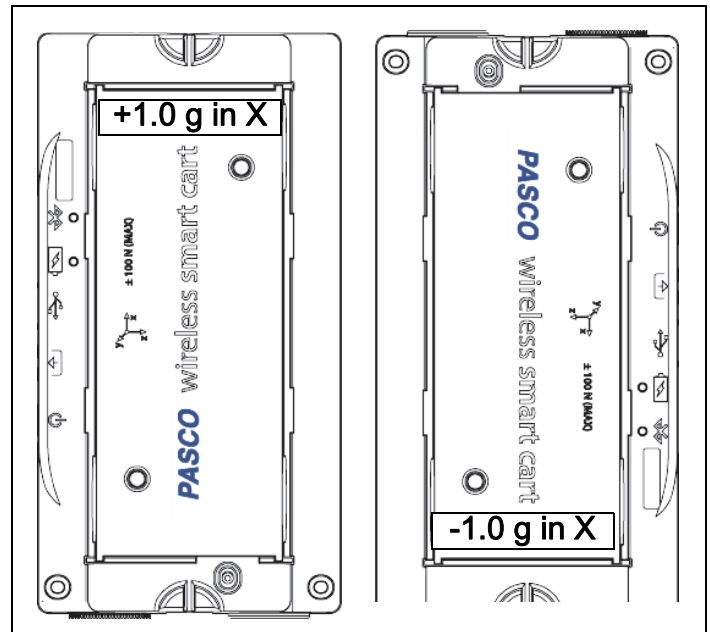

If the Smart Cart is held so that the accessory tray is on top and horizontal, the Acceleration Y-axis reading is 1.0 g. If the Smart Cart is turned so that the accessory tray is horizontal and on the bottom, the Acceleration Y-Axis reading is -1.0 g.

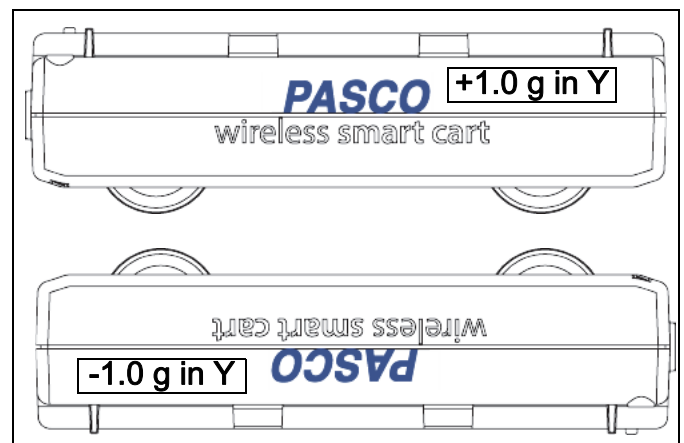

If the Smart Cart is placed so its side so that the Z-axis on the top of the cart is pointing upward, the Acceleration Z-axis reading is 1.0 g. If the Smart Cart is placed on its other side so the Z-axis is pointing downward, the Acceleration Z-axis reading is -1.0 g.

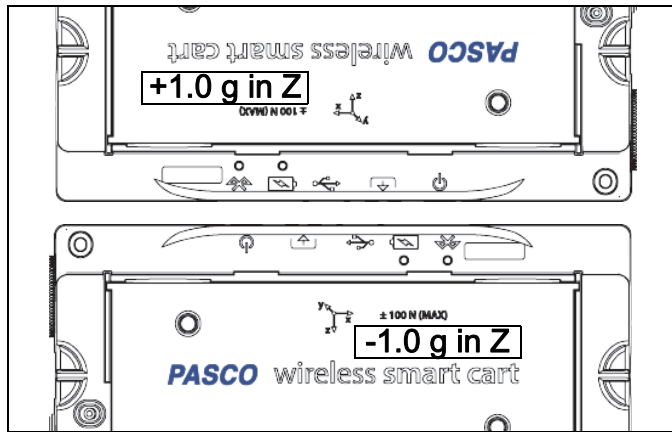

Smart Cart Accessories

For help in deciding on accessories for the Smart Cart, go to

www.pasco.com/products

and select **Carts and Tracks** under Product Families.

Accessories Include:

- Fan Accessory
- Smart Fan Accessory
- Ballistic Cart Accessory
- PAScar Cart Masses
- Compact Cart Mass
- IDS Spring Kit
- Dynamics Track End Stop (2 pack)
- Dynamics Track Feet (pair)
- Discover Collision Bracket
- Mechanical Oscillator/Driver
- PAStrack
- Curved PAStrack
- PAStrack Inclined Plane Accessory
- Classic Dynamics Tracks (1.2 and 2.2 m)

Systems

- Smart Cart Dynamics System 1.2 m

- Smart Cart Dynamics System 2.2 m

Mounting the Fan Accessory on the Smart Cart

- Snap the sides of the Fan Accessory over the rails on the accessory tray of the Smart Cart.

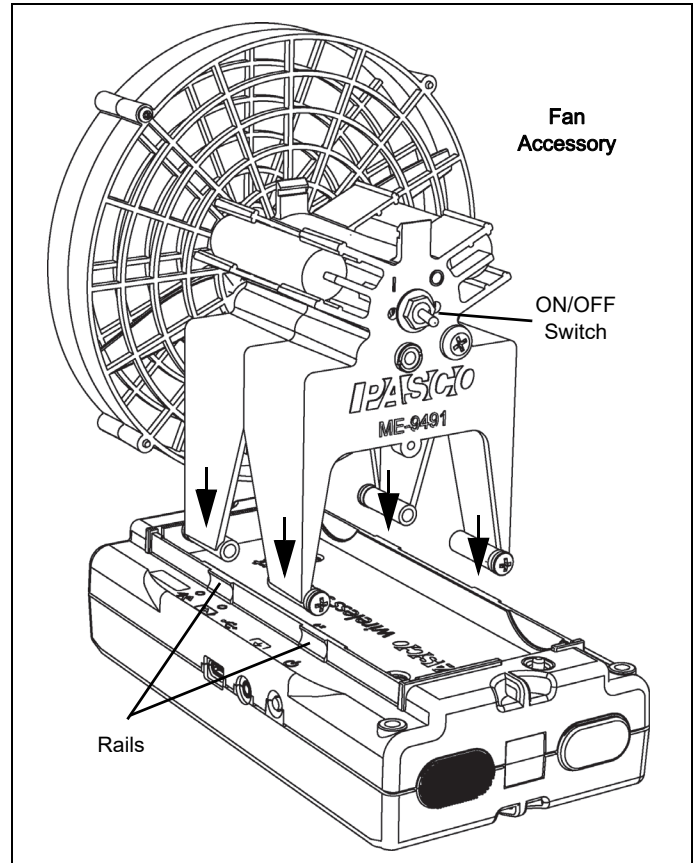

About the Battery

The Smart Cart's battery is partially charged at the factory. If the battery status LED blinks red, use the micro USB cable to connect the sensor to a USB port or a USB charger.

Battery Usage

Battery life is very important to making the product simple and always ready to use, so all of the PASCO wireless products are designed for long battery life. For example, the Smart Cart turns itself off after a few minutes of inactivity to conserve battery life.

The battery life between charges for the Smart Cart varies depending on the sampling rate. The battery life ranges between eleven hours for high sample rates to more than 70 hours for low sample rates.

In typical classroom/lab use, this would translate to a battery life between charges ranging from one to four

weeks or more, because full-day continuous sampling would be unusual. Even in the most extreme case with a high sample rate, the Smart Cart battery would support a full day of use before needing to recharge.

Maximizing Battery Life

One of the factors that affects battery life is the storage temperature. Therefore, avoid storing the Smart Cart in very cold or very hot environments.

Troubleshooting

If the Battery Status LED blinks red, use the micro USB cable to connect the Smart Cart to a USB port or a USB charger.

If the Smart Cart battery will not charge, it may need to be replaced. Contact Technical Support for information about battery replacement.

Suggested Experiments

Practically any experiment that has a force, acceleration, linear motion, or rotational motion measurement can be done with the ME-1240 or ME-1241 Smart Cart. See the PASCO Web site at

www.pasco.com/products/lab-manuals

for more information about experiments.

Calibrating the Sensors

The Smart Cart is factory calibrated. Further calibration is not necessary, especially if you are measuring a change in force, acceleration, or motion rather than absolute values. However, it is possible to calibrate the sensors. For detailed information, see Appendix C.

Specifications

Item: Force	Value
Range	±100 newtons (N)
Resolution	0.1 N
Accuracy	±1%
Maximum sampling rate	500 samples/second

Item: Position	Value
Resolution	±0.2 mm

Item: Velocity	Value
Maximum velocity	±3 m/s
Maximum sampling rate	500 samples/second

Item: Acceleration	Value
Range	±16g (g = 9.8 m/s ²)
Maximum sampling rate	500 samples/second

Item: Angular Rotation Rate	Value
Range	±245 degrees/second
Maximum sampling rate	500 samples/second

Bluetooth distance

30 m (unobstructed)

Technical Support

For assistance with any PASCO product, contact PASCO at:

Address: PASCO scientific
10101 Foothills Blvd.
Roseville, CA 95747-7100

Phone: +1 916 462 8384 (worldwide)
8700-772-8700 (U.S.)

Web: www.pasco.com/support

Email: support@pasco.com

The Reference Guide will be updated periodically. For the latest revision of this Reference Guide, visit the PASCO Web site at

www.pasco.com/manuals

and enter the product number, PS-3202, in the text window.

Replacement Parts

For information about replacement parts, contact Technical Support:

USB Cable, Micro-to-USB A
 Hook Attachment
 Bumper Attachment
 Magnetic Bumper (ME-9885A)

Limited Warranty

For a description of the product warranty, see the PASCO catalog. For more information visit www.pasco.com/legal

Copyright

This PASCO scientific *Reference Guide* is copyrighted with all rights reserved. Permission is granted to non-profit educational institutions for reproduction of any part of this manual, providing the reproductions are used only in their laboratories and classrooms, and are not sold for profit. Reproduction under any other circumstances, without the written consent of PASCO scientific, is prohibited. V: 4/16.

Trademarks

PASCO, PASCO scientific, PASCO Capstone, PASPORT, and SPARKvue are trademarks or registered trademarks of PASCO scientific, in the United States and/or in other countries. All other brands, products, or service names are or may be trademarks or service marks of, and are used to identify, products or services of their respective owners. For more information visit www.pasco.com/legal.

FCC Statement

This Class A digital device complies with part 15 of the FCC Rules. Operation is subject to the following two conditions: (1) This device may not cause harmful interference, and (2) this device must accept any interference received, including interference that may cause undesired operation.

CE Statement

This device has been tested and found to comply with the essential requirements and other relevant provisions of the applicable EU Directives.

Product End of Life Disposal Instructions:

This electronic product is subject to disposal and recycling regulations that vary by country and region. It is your responsibility to recycle your electronic equipment per your local environmental laws and regulations to ensure that it will be recycled in a manner that protects human health and the environment. To find out where you can drop off your waste equipment for recycling, please contact your local waste recycle/disposal service, or the place where you purchased the product.

The European Union WEEE (Waste Electronic and Electrical Equipment) symbol (to the right) and on the product or its packaging indicates that this product **must not** be disposed of in a standard waste container.



Battery Disposal Instructions:

Batteries contain chemicals that, if released, may affect the environment and human health. Batteries should be collected separately for recycling, and recycled at a local hazardous material disposal location adhering to your country and local government regulations. To find out where you can drop off your waste battery for recycling, please contact your local waste disposal service, or the product representative.

The Lithium Polymer (Li-Poly) rechargeable battery used in this product is marked with the International symbols to indicate the need for the separate collection and recycling of batteries.



Li-Poly

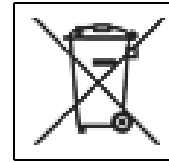

Appendix A: BluetoothSM Compatibility

Check the PASCO Web page at

www.pasco.com/wireless

for the latest information on Bluetooth SMART compatibility.

Platform	Bluetooth SMART Compatibility
iOS	iPad 3 and later iPhone 4S and later iPod touch 5 and later
SPARK Element	All models
Android	Android 4.3 and later
Chromebook	Chrome OS (requires PS-3500 Adapter*)
Mac OS X ¹	Models introduced July 2011 or later
Windows	Windows 7 and later (requires PS-3500 Adapter*)

*The PS-3500 USB Bluetooth 4.0 Adapter, when connected to a USB port, allows up to three Bluetooth SMART devices, such as this PASCO wireless device, to connect to Windows computers, Chromebooks, and older Macintosh computers.



Note: The PS-3500 USB Bluetooth 4.0 Adapter is the only adapter we can currently recommend. Many other Bluetooth 4.0 adapters are available but this adapter has a specific design that enables in-app pairing of Bluetooth SMART sensors.

¹To check the Mac computer’s Bluetooth compatibility, do the following:

- Click the  (Apple) Menu.
- Select *About This Mac*
- Click the *More Info...* button.
- Click the *System Report...* button.
- Select *Bluetooth* from the sidebar on the left, underneath *Hardware*.
- Scan down the list of information until you find “LMP Version”.
- If your Mac is equipped with Bluetooth SMART, the LMP Version will show **0x6**. (Anything lower than **0x6** means an older version of Bluetooth. Your device will need the PS-3500 USB Bluetooth 4.0 Adapter.)

¹The Mac Mini and MacBook Air were updated with Bluetooth SMART support in 2011. The MacBook Pro was updated in 2012. The Mac Pro that debuted in December 2013 has Bluetooth SMART support.

Exception: Please contact PASCO Technical Support for further instructions **before** you upgrade to **El Capitan** (Mac OS X 10.11.x), if you have a Macintosh with LMP version “0x4” that requires the PS-3500 USB Bluetooth 4.0 Adapter.

What is Bluetooth SMARTSM?

Bluetooth SMART (also known as Bluetooth Low Energy or Version 4.0 of the Bluetooth specification) is the latest protocol of the proprietary open wireless technology standard created by telecoms vendor Ericsson in 1994. It is the power- and application-friendly version of Bluetooth that was built for the Internet of Things (IoT).

Appendix B: Zero (tare) the Sensors

Zero (Tare) the Smart Cart

At the beginning of an experiment, the measurement from the built-in force and acceleration sensors may not be zero when the force or acceleration is actually zero. This is a normal behavior that is corrected when you zero (or tare) the sensor using the PASCO Data Collection Software.

See the SPARKvue Help for up-to-date information about zeroing the Smart Cart:

- In SPARKvue, select the HELP button () in any screen, such as the Home Screen.

In SPARKvue, the process for setting the Wireless Smart Cart to zero starts in the Home Screen ()

1. To zero the force sensor, start by selecting **Force** in the Home Screen to open a Graph display of Force versus Time.
2. In the Graph display, select the **Experiment Tools** () icon to open the **Experiment Tools** window.
3. In the **Experiment Tools** window, select **Configure Sensor** in the menu to open the **Sensor Configuration** window.
4. In the **Sensor Configuration** window, select the **Edit Sensor Properties** button to open the **Edit Sensor Properties** menu.
5. The **Edit Sensor Properties** menu shows two choices:

- **Smart Cart Force Sensor**
 - **Smart Cart Acceleration Sensor.**
6. Select the **Smart Cart Force Sensor** choice from the menu to open the **Edit Sensor Properties** window.
 7. The **Edit Sensor Properties** window offers two choices under **Tare Sensor**:
 - **Zero Sensor Automatically On Start:**
 - **Zero Sensor Now**
 8. In the **Edit Sensor Properties** window, select **Zero Sensor Automatically On Start** if you want the sensor to be set to zero every time that data collection begins. **Select Zero Sensor Now** to set the sensor to zero manually.
 9. Select **OK** at the bottom of the window to return to the Graph display.

To zero the acceleration for the Acceleration Sensor, return to the **Home Screen** (). (NOTE: There may be a message about saving your data.)

1. To zero the **Smart Cart Acceleration Sensor**, start by selecting any of the choices for acceleration in the **Home Screen** to open a Graph display of Acceleration versus Time.
2. In the Graph display, select the **Experiment Tools** () icon to open the **Experiment Tools** window.
3. Follow the same procedure that you used for setting the force measurement to zero.

See the PASCO Capstone Help for up-to-date information about zeroing the Smart Cart:

- In PASCO Capstone, select **PASCO Capstone Help** from the **Help** menu, or press **F1**.

In PASCO Capstone, there are options for setting the Wireless Force Sensor to zero.

One option is to use the **Zero** button:

1. Select **Smart Cart Force Sensor** from the **Common Rate** menu and then click the **Zero** button. This will set the sensor reading to zero.



2. Repeat the process to zero the **Smart Cart Acceleration Sensor** if needed.

Another option is to select a choice in the sensor's Properties palette:

1. Click **Hardware Setup** in the **Tools** palette to open the **Hardware Setup** window.

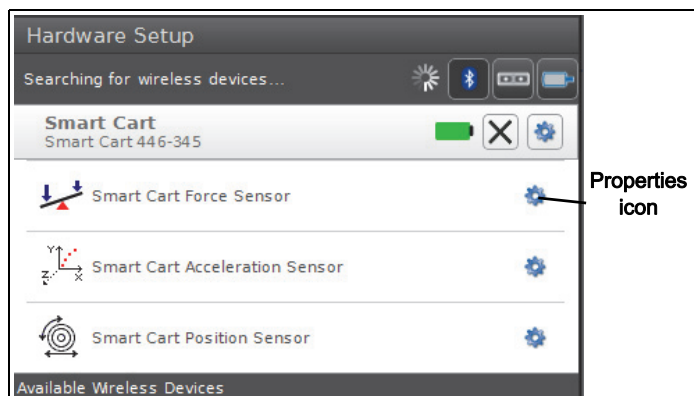

2. Click the Properties icon for the **Smart Cart Force Sensor** to open the **Properties** window.
3. In the **Properties** window, select one of the three choices and then click **OK** at the bottom to close the window.

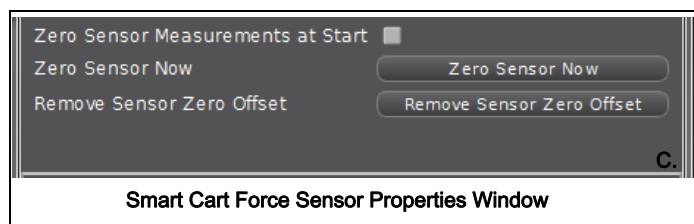

- **Zero Sensor Measurements at Start** – Zero the Wireless Force Sensor at the start of data collection.
 - **Zero Sensor Now** – Works the same as the Zero button.
 - **Remove Sensor Zero Offset** – Undo. Return the Wireless Force Sensor to its previous state.
4. Repeat the process for the Smart Cart Acceleration Sensor if needed.

Appendix C: Calibration

The Smart Cart is factory calibrated, so calibration is not necessary, especially if you are measuring a change in force rather than absolute force values. However, it is possible to calibrate the sensor.

Prepare for Calibration

Calibration will need a 1 kilogram mass, the hook attachment, string, and a horizontally mounted support rod to hold the Smart Cart. The Smart Cart will need to be “connected” with a tablet or computer, and the data collection software (for example, SPARKvue) should be running.

Using SPARKvue Software for Calibration

See the SPARKvue Help for information about calibrating:

- In SPARKvue, select the HELP button (?) in any screen, such as the Home Screen.
1. Screw the hook attachment into the Smart Cart.
 2. Use string tied to the two attachment points on the pad end of the Smart Cart to hang the cart from a horizontal rod.

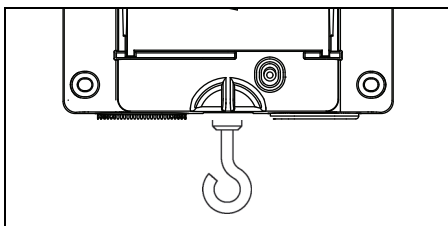

3. Click (or press) the Experiment Tools button (X).
 - The **Experiment Tools** screen opens.
4. Click **Calibrate Sensor**.
 - The **Calibrate Sensor: Select Measurement** screen opens.
5. Click the **Sensor** box and click the sensor to be calibrated.
6. Click the **Calibration Type** box and click a calibration type. (For this example, click “**2-point**”.)
7. Click **Next**.
 - The **Calibrate Sensor Enter Values** screen opens.
8. Hang the 1 kilogram mass on the hook attachment.
9. The gravitational force on the mass is pulling in the negative direction at -9.8 newtons (N). Under **Calibration Point 1**, click the **Standard Value** box and enter the known force value (that is, -9.8).
10. Under **Calibration Point 1**, click **Read From Sensor**.

- The value measured by the sensor is transferred to the **Sensor Value** box.
11. Remove the 1 kilogram mass from the hook attachment. The net force now is zero N.
 12. Under **Calibration Point 2**, click the **Standard Value** box and enter the second known force value (i.e., 0).
 13. Under **Calibration Point 2**, click the **Read From Sensor** box.
 - The second value measured by the sensor is transferred to the **Sensor Value** box.
 14. Click **OK**.

Using PASCO Capstone for Calibration

See the PASCO Capstone Help for information about calibrating:

- In PASCO Capstone, select **PASCO Capstone Help** from the **Help** menu, or press **F1**.
1. Screw the hook attachment into the Smart Cart.
 2. Use string tied to the attachment points on the pad end of the Smart Cart to hang the cart from a horizontal rod.
 3. Click **Calibration** (⊕) in the **Tools** palette.
 4. Choose the measurement you would like to calibrate now: **Force Measurement**.
 5. Click **Next**.
 6. Choose the type of calibration you would like to perform: **Two Standards (2 point)**.
 7. Click **Next**.
 8. Hang the 1 kilogram mass on the hook attachment.
 9. The net force on the sensor is -9.8 N. Enter the value in the **Standard Value** text box.
 10. When the **Current Value** stabilizes, click **Set Current Value to Standard Value**.
 11. Click **Next**.
 12. Remove the 1 kilogram mass from the hook attachment. The second force value is zero N.
 13. Enter the second known force value (i.e., 0) in the **Standard Value** text box.

14. When the **Current Value** stabilizes, click **Set Current Value to Standard Value**.

15. Click **Next**.

16. Click **Finish**.

Theory of Calibration

One of the functions of the PASCO Data Collection Software is to take the stream of raw data from a sensor and transform it into the calibrated data that you see in the Graph, Table, and other displays. If you do not calibrate a sensor yourself, the software uses a default calibration that is loaded when the sensor is connected.

You can think of the software as taking in raw data and outputting calibrated data. When you perform a calibration, the software redefines the linear equation that transforms the raw input data into the calibrated output data. The linear function is of the form:

$$\text{Raw Input} = \text{Slope} \times \text{Calibrated Output} + \text{Offset}$$

Or:

$$\text{Calibrated Output} = (\text{Raw Input} - \text{Offset}) / \text{Slope}$$

The function can be represented graphically as a line.

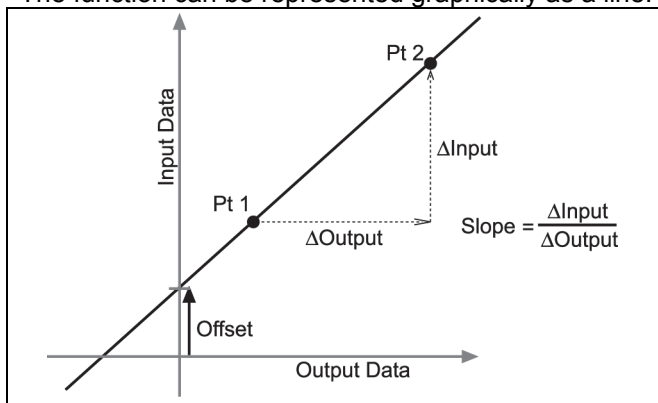

Two points, Pt 1 and Pt 2, define the line. In the two-point calibration procedure, each point is reset by associating a known standard value (for instance, the temperature of ice water) with a raw input measurement that the sensor sends out when it is in that standard. In a one-point calibration, only one of the points is reset by the user.

Types of Calibration

There are three types of calibration: two-point, one-point slope, and one-point offset. Any of these calibrations can be performed on a single sensor, or simultaneously on multiple similar sensors; however, for any given sensor, the software will automatically select the most typical calibration type as the default setting.

Two-Point

In a two-point calibration, you reset two points to define a new line. This type of calibration affects both the slope and the offset.

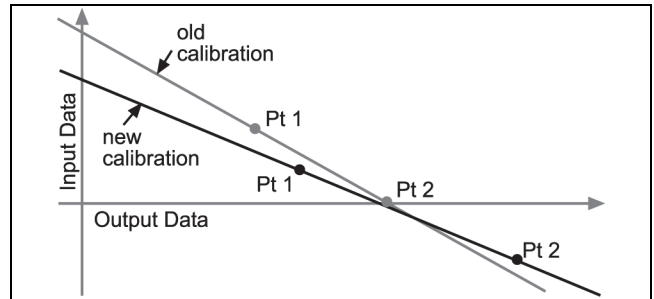

One-Point Slope

In a one-point slope calibration, you reset only one point. The slope of the line changes so that the line intersects the new point, while the offset (or Y-intercept) does not change.

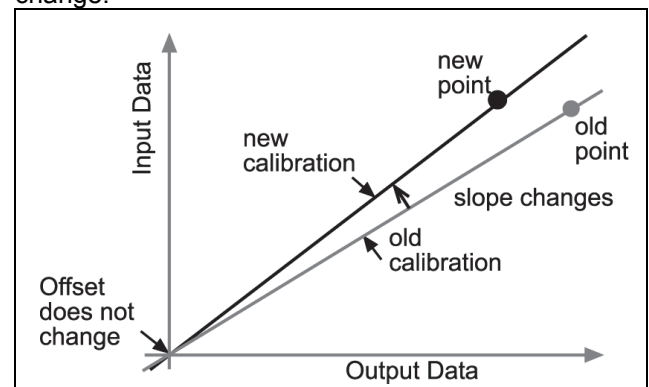

One-Point Offset

In a one-point offset calibration, you reset only one point. The line shifts so that it intersects the new point, but its slope does not change.

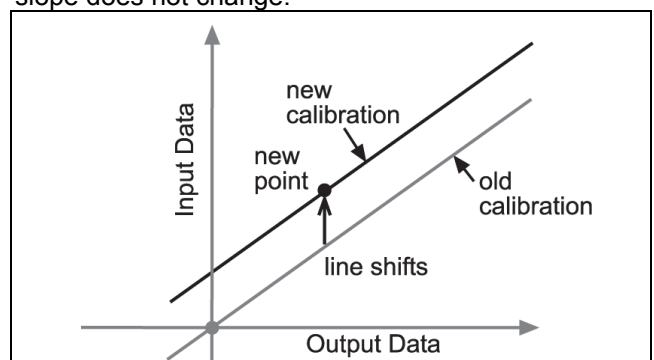

Offset calibration is usually used to make one sensor agree with another sensor. Due to normal variation among probes, a second probe might read consistently higher than the first probe. Normally this difference would be insignificant; however, an offset calibration can be used to bring the sensors into closer alignment.