

Colorimeter

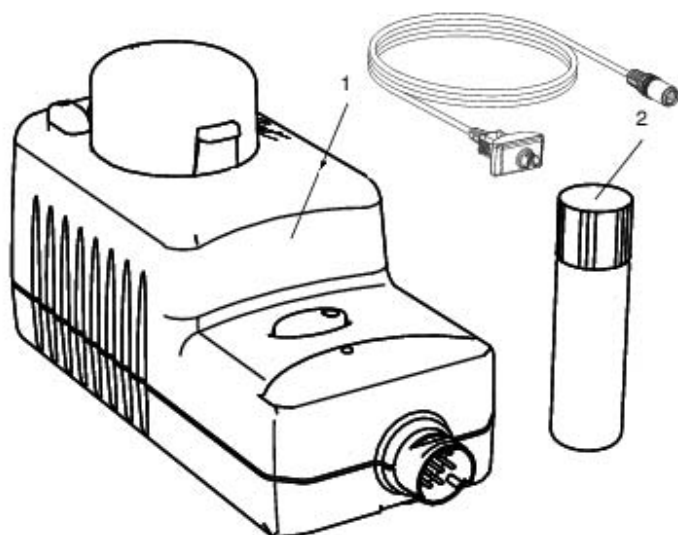

Included Parts

1. Colorimeter
2. Cuvettes with caps, 5 pieces
 - Cuvette labels (not pictured)
 - Storage box (not pictured)
 - Extension Cable

Additional Part Required

- interface or datalogger

Quick Start

1. Connect the Colorimeter to your interface (may require Extension Cable).
2. If you are using a computer, connect the interface to it and start DataStudio.
3. Fill a cuvette with a solution.
4. Put the cuvette in the Colorimeter and close the lid.
5. Press or click the start button to begin recording data.

Introduction

The Colorimeter measures the absorbance and transmittance of different colors of light through solutions. These measurements can be used to determine a solution's concentration.

Set-up

Connecting the Colorimeter to an Interface

1. Connect the Colorimeter's plug to any port of a interface or datalogger. Optionally, use a extension cable between the interface and the Colorimeter.
2. If you are using a computer, connect the interface to it and start DataStudio.

Collecting Data

1. Fill a cuvette with a solution and screw on the cap. See "Sample Preparation" below.
2. Put the cuvette in the Colorimeter and close the lid.
3. Ensure that the Colorimeter is horizontal.
4. Press or click the start button to begin recording data.

Measurements

The Colorimeter makes eight measurements: absorbance and transmittance of red, orange, green, and blue light. Select any of these measurements in software or on the interface.

Sample Rate

By default, the sensor collects 1 sample per second. It can collect data as fast as 5 samples per second. Change the sample rate in software or on the datalogger.

Calibration

Calibration is not always required, but is recommended for better accuracy. Calibration is stored in the Colorimeter; when you

Colorimeter

unplug the sensor and reconnect it, the sensor retains the last calibration.

1. Fill a cuvette with distilled water (or other solvent representing a concentration of zero) and screw on the lid. See "Sample Preparation" below.
2. Put the cuvette in the Colorimeter and close the lid.
3. Press the **Calibration** button on the sensor. A light in the button illuminates to indicate that calibration is in progress.
4. Wait for the light to turn off and then remove the sample.

After calibration, the transmittance of the calibration sample should read 100% for all colors.

Sample Preparation

1. Fill the cuvette with at least 6 ml of sample.
2. Screw the cap on securely.
3. Handle the cuvette by the cap and wipe the glass clean with a non-abrasive tissue. Avoid touching the glass.
4. Gently rock the cuvette to distribute the solute molecules equally throughout the solution. Do not shake the cuvette or allow air bubbles to enter the solution.

Orienting the Cuvette

To minimize reading variance due to differences or imperfections in the glass of the cuvette, do the following for each cuvette you plan to use.

1. Put a cuvette containing distilled water or other solution into the Colorimeter. Keep the lid of the Colorimeter open.
2. Put a piece of black cloth over your hand and the Colorimeter so that no light can enter the Colorimeter.
3. Start data collection in software or on the interface.
4. With your covered hand, rotate the cuvette while observing the transmittance reading. At the highest transmittance reading, stop rotating.
5. With the cuvette still in the Colorimeter, place one of the provided arrow labels on the cap with the arrow pointing toward the screw on the edge of the cuvette holder.

For subsequent measurements and calibrations, always place the cuvette in the Colorimeter with the arrow pointing toward the screw. Do not switch caps between cuvettes.

Activity: Transmittance and Absorbance of Different Colors

Equipment Required: Colorimeter, interface, distilled water, red food coloring, and two cuvettes.

1. Connect the Colorimeter to the interface as described above (may require PASport Extension Cable).
2. Fill one cuvette with distilled water and screw the cap on securely.
3. Fill another cuvette with a solution of 2 drops of red food coloring in 6 ml of water. Screw on the cap, then gently rock the cuvette to mix the solution without creating bubbles.
4. Put the cuvette containing distilled water into the Colorimeter and close the lid.
5. Collect a short run of data.
6. Put the cuvette containing the colored solution into the Colorimeter and close the lid.
7. Collect another short run of data.

Compare the absorbance and transmittance of each color for each sample. Does the distilled water absorb or transmit one color more than the others? Which color does the red solution absorb most? Which color does it transmit most?



Sample data: transmittance of red, orange, green and blue light through a red solution.

Suggested Experiments

- Beer's Law: find the relationship between the concentration and the absorbance of a solution. Use this relationship to determine the concentration of an unknown sample.
- Reaction rate: measure changing absorbance over time as a chemical reaction occurs in the cuvette.

Specifications

Range	0% to 100% transmittance
Wavelengths	660 nm (red) 610 nm (orange) 565 nm (green) 468 nm (blue)
Accuracy	± 0.5% transmittance
Resolution	0.1% transmittance
Default sample rate	1 sample/s
Maximum sample rate	5 samples/s
Temperature range (for sensor and test sample)	5° C to 40° C (recommended)

Drop Counter

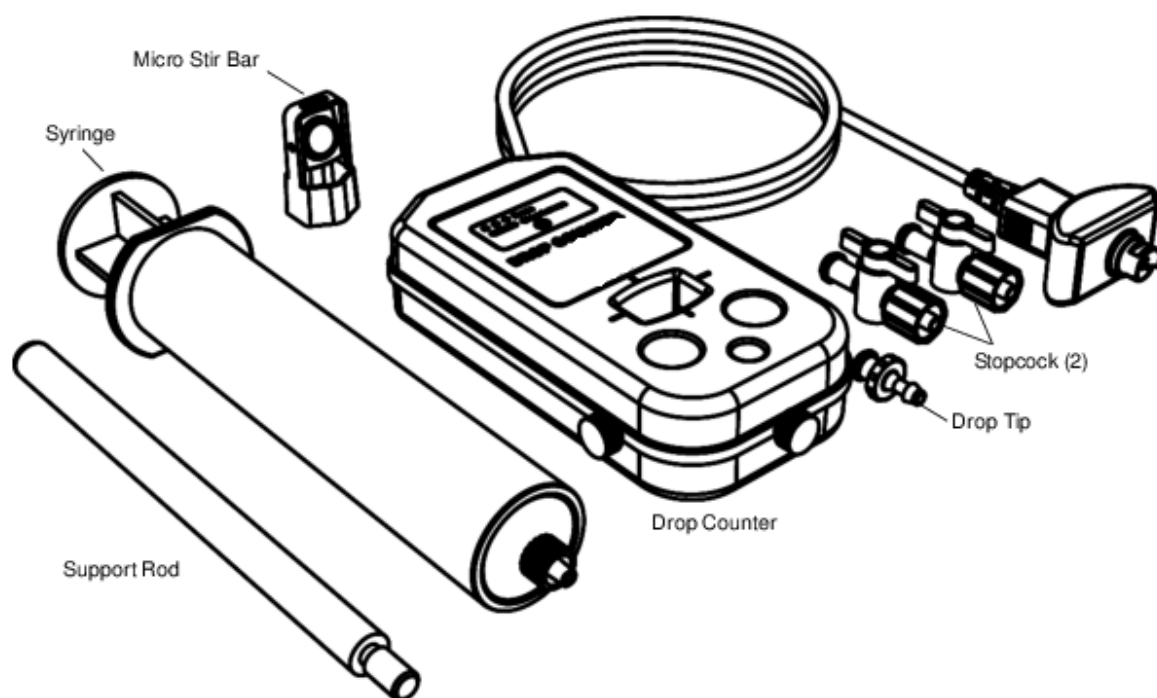

Included Items	Included Items
Drop Counter	Stopcock (2)
Micro Stir Bar	Drop Tip
Syringe (60 mL)	Support Rod

Other Needed Items*
Three-finger Clamp (SE-9445)
Support Rod and Stand (SE-9451)
Multi Clamp (ME-9507)
Magnetic Stir Plate (SE-7770)
Beaker, 150 mL
Graduated Cylinder, 10 mL

Required Items	Required Items
PASCO Interface*	Data Acquisition Software*

*See the PASCO catalog or the PASCO web site at www.pasco.com for more information

Recommended	Recommended
pH Sensor*	Temperature Sensor*

Consumables	Consumables
0.1 M NaOH	0.005 M HCl

Quick Start

1. Connect the Drop Counter to your PASPORT compatible PASCO interface.
2. If you are using a computer, connect the interface to it and start the data acquisition software.
3. Touch, press, or click to begin recording data.
4. Allow drops of liquid to fall through the rectangular opening.

Introduction

The Drop Counter measures the number of drops of fluid that fall through the rectangular opening of the sensor. It is typically used in conjunction with a pH sensor and other equipment to perform a titration. Data from the Drop Counter and other sensors are recorded and displayed in software such as SPARKvue, PASCO Capstone, or on a datalogging interface such as the SPARK SLS or Xplorer GLX.

The Drop Counter can be mounted on a support rod and the support rod can be clamped to a rod stand. The counter is equipped with three integrated probe holders. The included Micro Stir Bar fits onto the end of a pH probe or probe of the same diameter.

Assembling the Drop Dispenser

1. Remove the plunger from the syringe.
2. Connect the two stopcocks together and set the valves at right angles. Connect the stopcocks to the end of the syringe.
3. Connect the drop tip to the bottom of the stopcocks.

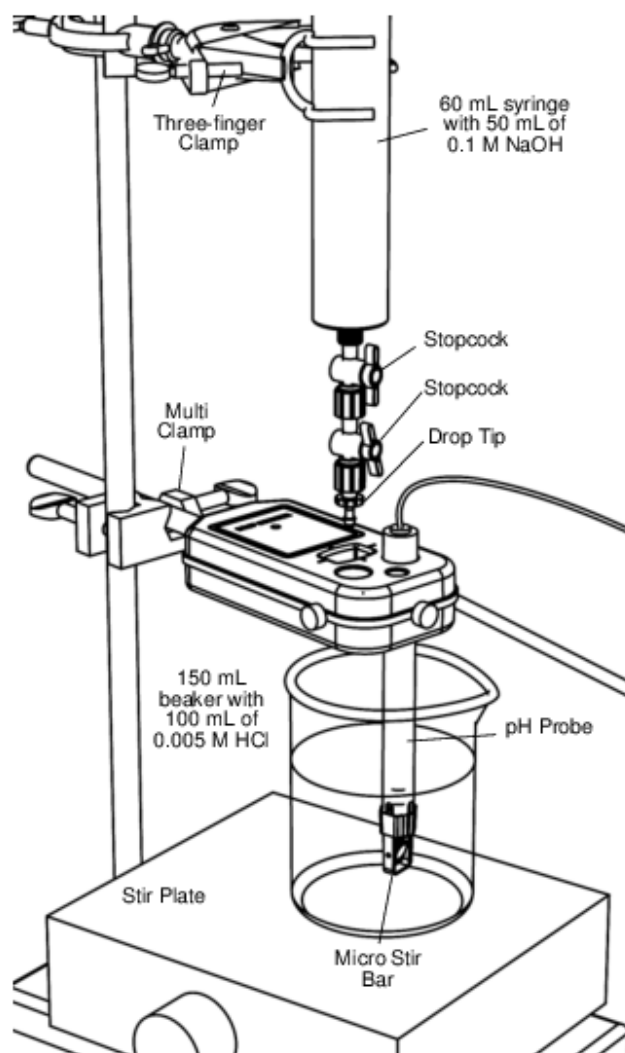

Acid-Base Titration (Calibration Method)

Calibration

1. Attach the Drop Dispenser (syringe, stopcocks and drop tip) to a support rod.
2. Fill the syringe with titant and adjust the valves on the stopcocks so that the drops fall at a rate of about 1 drop per second. Close the bottom valve after the rate is achieved.
3. Connect the Drop Counter to a PASPORT-compatible interface.
4. Align the drop tip with the opening in the Drop Counter. Put a 10 ml graduated cylinder under the Drop Counter opening.
5. Open the bottom stopcock valve and monitor the number of drops per 10 mL of titrant.
6. Open the calibration screen in the data acquisition software and input the number of drops and the volume.

Procedure

1. Setup the equipment and consumables as shown.
2. Connect the Drop Counter and pH Sensor to the PASPORT-compatible interface.
3. Start the data acquisition software.
4. Use the software to create a graph of pH vs. Fluid Volume.
5. Start the stir plate.
6. Touch, press, or click to begin recording data.
7. Open the valve on the bottom stopcock so the titrant drops fall at about 1 drop per second.

- Observe the data on the pH versus Fluid Volume graph. After the equivalence point is reached, continue collecting data until the pH curve flattens.

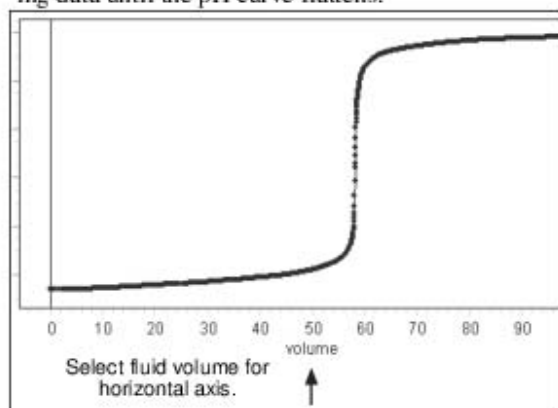

- Close the stopcock valve and stop data recording.

Acid-Base Titration (Alternative Method)

Procedure

- Set up the equipment and consumables as illustrated. Attach both stopcocks to the syringe, and attach the drop tip to the bottom stopcock. Line up the drop tip with the rectangular opening in the Drop Counter.
- Start with the valves of the stopcocks turned parallel to the table top. Add the solutions to the syringe and beaker.
- Write down the initial volumes of both solutions (in the syringe and in the beaker), and the molarity of the titrant (in the syringe).
- Connect the Drop Counter and pH sensor to your PASPORT compatible PASCO interface (or interfaces).
- If you are using a computer, connect the interface to it and start the data acquisition software. Set up a graph display of pH versus Drop Count.
- Start the stir plate.
- Touch, press, or click to begin recording data.
- Open the top stopcock. Slowly adjust the bottom stopcock to start delivering titrant at about 2 drops per second.
- Observe the data appearing on the pH versus drop count graph. After the equivalence point is reached, continue collecting data until the pH curve flattens.

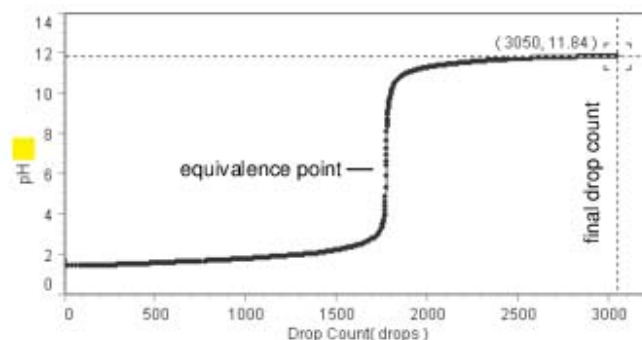

- Close the stopcocks.
- Stop data recording.
- Read the final volume of fluid in the syringe and calculate the net volume of titrant that was dispensed.
- Read the final drop count on the graph.
- In the calculator window of the software or datalogger, enter a calculation as shown below, but using your own values of total volume dispensed and final drop count. The calculation gives the volume of titrant dispensed over time based on the number of drops and the average volume per drop.

$$\text{volume} = [\text{Drop Count (drops)}] * 100/3050$$

In this example, "100" is the total volume dispensed (in mL) and "3050" is the final drop count.
- In the graph, change the horizontal axis to the calculated "volume".

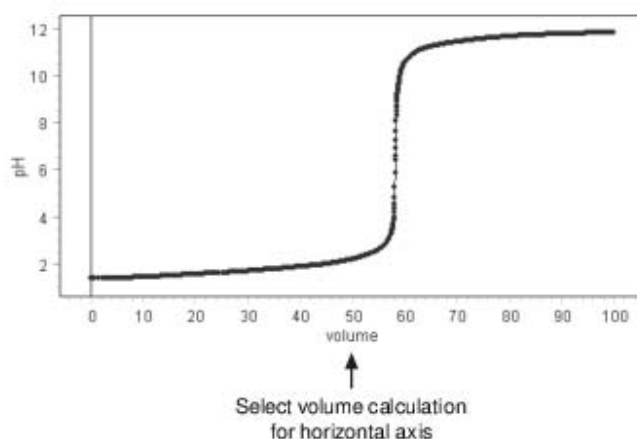

Tips

- Except for opening and closing the stopcocks, do not touch the syringe during the titration; otherwise, the drop size may change significantly.
- The drop rate must remain approximately constant (about 2 drops per second) in order for the drop size to remain constant.
- Drop size depends on the exact position of the bottom stopcock. Therefore, the average drop size will be different for every titration. For each titration, re-enter the volume used and drop count values in the calculation.

Other Titrations

Titration with different solutions can be performed using the same equipment and procedure. Other probes (such as conductivity or ORP) can be used in place of the pH probe.

Theory of Operation

The Drop Counter uses an infrared light source and a photodetector. Lenses spread the light into a “sheet” and refocus it onto the photodetector. When a drop of fluid passes through the Drop Counter, it partially blocks this sheet of light, and the photodetector registers a momentary decrease in light intensity.

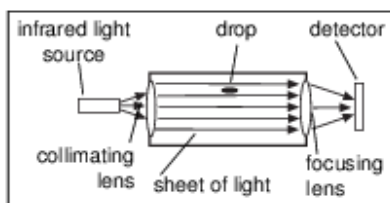

The Drop Counter uses infrared light and ignores visible light. On power up, it automatically adjusts the light level for the best sensitivity. Use the Drop Counter away from direct sunlight or other sources of infrared that may interfere with it.

Troubleshooting

Problem	Cause	Solution
Indicator light flashes twice for a single drop. Drop Counter registers more drops than actually dispensed.	Fluid is splashing back into the drop window.	Adjust the position of the beaker, Drop Counter, or syringe to eliminate splash back
Indicator LED remains on constantly. Drop Counter does not register drops.	Lenses in drop window are dirty or wet.	Clean lenses with water and dry with a cotton swab or tissue.

Specifications

Item	Value
Range:	-35 to 135°C
Accuracy:	±0.5°C
Resolution:	0.01°C or better
Response Time	Wait 15 seconds for stable readings in liquids, and wait 30 to 60 seconds for stable readings in gases.

Product End of Life Disposal Instructions:

This electronic product is subject to disposal and recycling regulations that vary by country and region. It is your responsibility to recycle your electronic equipment per your local environmental laws and regulations to ensure that it will be recycled in a manner that protects human health and the environment. To find out where you can drop off your waste equipment for recycling, please contact your local waste recycle/disposal service, or the place where you purchased the product.

The European Union WEEE (Waste Electronic and Electrical Equipment) symbol (to the right) and on the product or its packaging indicates that this product must not be disposed of in a standard waste container.



Chemistry MultiMeasure Sensor

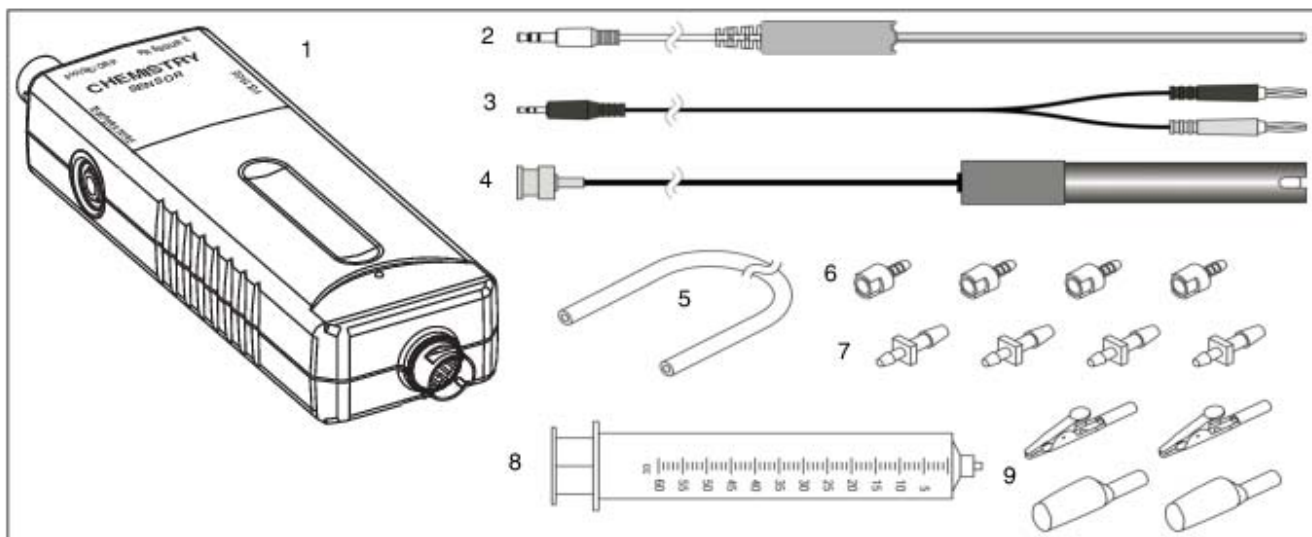

Included Equipment

1. Chemistry MultiMeasure Sensor
 2. Stainless Steel Temperature Probe
 3. Voltage Probe
 4. pH Electrode
 5. Polyurethane Tubing (60 cm, 0.125 inch ID)
 6. Quick-release Connectors (qty. 4)
 7. Tubing Connectors (qty. 4)
 8. Syringe (60 cc)
 9. Alligator Clip with Insulator (qty. 2 each)
- Polyurethane Tubing, (blue, 15 cm, 0.25 inch OD) *not shown*
- Hose and Coupling Kit

Required Equipment

PASPORT Interface and
Data Acquisition Software

Optional Equipment

Fast-response Temperature Probe

Skin/surface Temperature Probe

Various Ion-selective Electrodes (ISE)

Oxidation Reduction Potential (ORP) Electrode

Introduction

The Chemistry MultiMeasure Sensor combines four sensors in a single unit:

- Temperature
- Absolute gas pressure (built-in)
- pH, ORP, and ion-selective electrode voltage
- Voltage

The sensor includes a temperature probe, a voltage probe, and a pH electrode. The pressure sensing element does not use an external probe. The sensor comes with alligator clips and insulators, a syringe, blue polyurethane tubing and a Hose and Coupling Kit.

When connected to a PASPORT interface, the multi-sensor collects data at up to 100 samples per second from each component sensor. You can use just one component sensor at a time or any combination simultaneously. If you have a PASPORT interface that supports multiple sensors, or if you have more than one interface connected to your computer, you can use the Chemistry MultiMeasure Sensor in combination with other PASPORT sensors.

Sensor, Interface, and Software Setup

Connect the multi-sensor to your PASPORT interface as pictured (right). Connect any or all of the included probes to the multi-sensor. (You can leave any of the probes disconnected if you do not plan to use it.) If you will be using a pH Electrode (included) or an ion-selective electrode or oxygen reduction potential electrode, connect it to the pH/ISE/ORP port (BNC port). Align the grooves of the BNC connector on the probe with the pins on the BNC port. Push the connector onto the port and turn the connector clockwise until it locks in place. If you plan to measure pressure in an apparatus or the included syringe, connect it to the sensor's pressure port using the included clear tubing and a quick-release connector.

For detailed information about each of the multi-sensor sensor's component sensors see pages 4–6.

Follow the instructions in the Computer Setup section to set up the sensor with a PASPORT-compatible interface connected to a computer using PASCO Capstone or SPARKvue HD software.

Follow the instructions in the Wireless Setup section to set up the sensor with a mobile device such as a tablet or smart phone using a wireless interface such as the AirLink2 or SPARKlink and the SPARKvue HD software.

Follow the instructions in the Hand-Held Setup section to set up the sensor with a SPARK Science Learning System (SPARK SLS) or the Xplorer GLX hand-held data-logger.

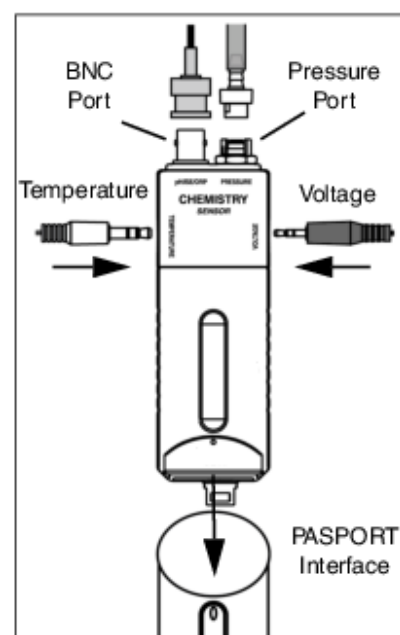

Computer Setup

Using PASCO Capstone

- Connect a PASPORT-compatible interface to the computer and start the PASCO Capstone software. (Refer to the documentation that came with your PASPORT interface for instructions on connecting it to your computer.) In Capstone, click the Record button to begin data collection; click the Stop button to stop data collection.

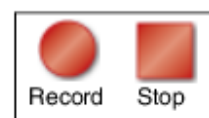

- Note that the sensor may collect data for probes that are not connected. To hide measurements that you do not need, click the Data Summary icon (📊) in the Tools palette to open the Sensor Data Summary panel. Click the Visibility icon (👁) to view the menu of parameters. Check or un-check the measurements as needed. Click the Data Summary icon again to close the panel.

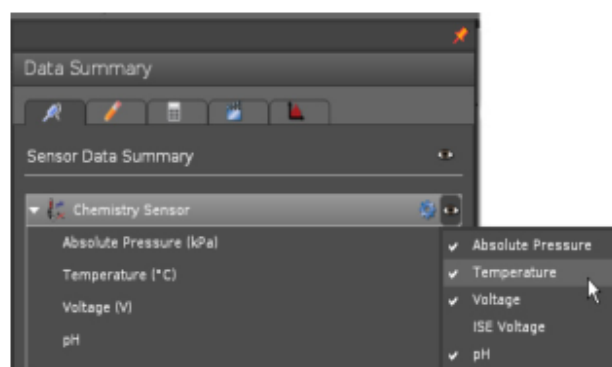

- In the Workbook page, click one of the configured display combinations, or drag icons from the Displays palette into the Workbook page. In a display, click the "<Select Measurement>" menu to view the sensor parameter choices. Click a parameter in the menu to set the measurement for that display.

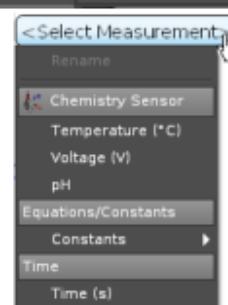

Using SPARKvue HD

- Connect a PASPORT-compatible interface to the computer and start the SPARKvue HD software. (Refer to the documentation that came with your PASPORT interface for instructions on connecting it to your computer.) In SPARKvue HD, the opening screen shows the list of measurements for the sensor. For example, click "Temperature" and then click "Show" to open a Graph display screen.
- In the Graph display screen, click the green Record button (▶) to begin recording data. Click the red Stop button (◻) to stop recording data.

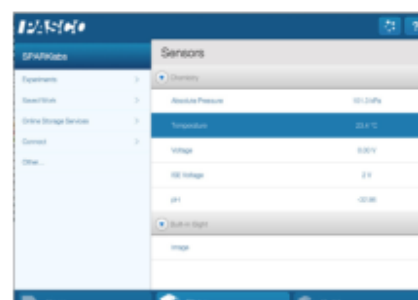

Wireless Setup

Using SPARKvue HD

- Use the SPARKvue HD software to pair a mobile device such as a tablet or smart phone to a PASCO wireless interface such as the AirLink2 or SPARKlink Air. (Refer to the documentation that came with your PASCO wireless interface for instructions on connecting it to your mobile device.)
- Connect the sensor to the wireless interface. In SPARKvue HD, the opening screen shows the list of measurements for the sensor. For example, touch "Temperature" and then touch "Show" to open a Graph display screen.
- In the Graph display screen, touch the green Record button (▶) to begin recording data. Touch the red Stop button (◻) to stop recording data.



Hand-held Setup

Using the SPARK SLS

- Connect the sensor to a port on the SPARK SLS and turn on the interface. The sensor parameter screen opens and shows the list of measurements for the sensor.
- In the sensor parameter screen, touch or click the measurement, and then touch 'Show' to open a graph display of the measurement.
- Touch "Start" (▶) to begin recording data. Touch "Stop" (▶) to stop recording data.

Using the Xplorer GLX

- Turn on the interface and connect the sensor to a port on the top. A Digits display of Absolute Pressure (kPa) and Voltage (V) opens automatically and shows the data being monitored.
- Press the **Start/Stop** key (▶) to begin recording data. Press the same key again to stop recording.
- Note that the sensor may collect data for probes that are not connected. Hide or ignore these measurements. To hide measurements that you do not need, open the Sensors screen (from the Home screen, press (F4)). In the Sensors screen, use the up or down cursor keys to highlight a measurement. Press "Check" (✓) to change the visibility of that measurement. (You can also change the sampling rate and open the calibration dialog box from the Sensors screen.)

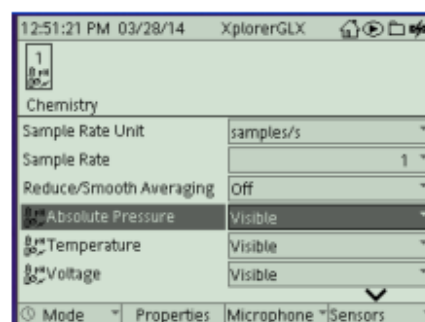

Calibration Information

See the Appendices for detailed information about calibrating the sensor.

Temperature

Use this component of the multi-sensor to measure the temperature of a fluid or object. The measurement can be displayed in units of °C, °F, or K. You can use the included stainless steel probe or a different probe, such as the Fast-response Temperature Probe (PS-2135) or Skin/Surface Temperature Probe (PS-2131). PASCO apparatus containing an embedded 10 k Ω thermistor can also be connected to the multi-sensor. The multi-sensor automatically detects the presence of a temperature probe, and it will only collect temperature data if a probe is connected.

Measuring Temperature

To measure temperature, connect the probe and start data collection. Immerse the tip of the probe in a fluid or place it in contact with an object. The stainless steel probe can be used in both dry conditions and in liquids, such as water and other mild chemicals and solutions*. The included blue polyurethane tubing allows the stainless steel probe to fit inside a standard 0.25" diameter stopper hole.

Tip: For better chemical resistance, use a Teflon® cover (CI-6549).

Temperature Calibration

The temperature measurement can be calibrated; however, for most applications calibration is not necessary. Use a two-point calibration with two standards of known temperature. For instructions on calibrating the sensor, see the Appendices.

pH/ISE/ORP

The pH/ISE/ORP input of the multi-sensor is a specialized voltage sensor. Its BNC connector accepts the included pH electrode, as well as ion selective electrodes (ISE) and oxygen reduction potential (ORP) electrodes. The sensor measures the voltage produced by any of these electrodes. When used with a pH electrode, the sensor also computes the pH based on the measured voltage.

Connect the pH electrode (or other electrode) to the pH/ISE/ORP port and start data collection. On your computer or interface, display the **ISE Voltage** measurement (this measurement is valid for pH and ORP electrodes as well as ISE) or the **pH** measurement for the calculated pH (assuming that the pH electrode is connected).

Measuring pH

The pH electrode produces a voltage proportional to the pH of the solution that it is immersed in. This voltage is measured by the multi-sensor, which computes pH.

Unscrew and remove the storage bottle from the electrode (be careful not to spill the storage solution). Push the O-ring and bottle cap up the electrode handle. Rinse the electrode tip with distilled water. If you see bubbles in the electrode bulb, gently shake the electrode downward (similar to shaking down a thermometer). Start data collection. Place the tip of the electrode in the solution to be measured and wait for the reading on your computer or interface to stabilize. Rinse the electrode with distilled water before measuring another solution.

pH Calibration

The pH measurement can be calibrated; however, for most applications calibration is not necessary. Perform a two-point calibration with two buffer solutions of known pH. For instructions on calibrating in the sensor for pH, see the Appendices.

pH Electrode Maintenance and Storage

Cleaning

If the pH electrode becomes contaminated, use one of these methods to clean and restore it. After any of these procedures, rinse the electrode with deionized water and soak the electrode in the electrode storage solution for 1 hour.

- **General Cleaning:** Soak the electrode in 0.1 molar hydrochloric acid (HCl) or 0.1 molar nitric acid (HNO₃) for 30 minutes.
- **Bacterial Growth:** Soak the electrode in a 1:10 dilution of household laundry bleach for 15 minutes.
- **Protein Deposits:** Soak the electrode in a solution of 1% pepsin in 0.1 molar HCl for 15 minutes.
- **Inorganic Deposits:** Soak the electrode in 0.1 molar tetra sodium EDTA (ethylenediaminetetra-acetic acid) solution for 15 minutes.
- **Oil and Grease Film:** Wash the electrode carefully in a mild detergent or a solvent known to be effective for the particular film.
- **Unknown Contamination:** Soak the electrode alternately in 1 molar sodium hydroxide (NaOH) and 1 molar HCl. Leave it in each solution for one minute. Rinse completely between soakings. End with HCl. (The NaOH etches the glass and the HCl reestablishes hydrogen ions on the surface.)

If these steps fail to improve the response of the electrode, replace it with a PS-2573 pH Electrode (or equivalent).

Storage

Store the pH electrode in the included electrode storage bottle with one of the following solutions. (Never store the electrode in distilled water.)

- **Short-term** (up to one week): pH 4 buffer solution or tap water.
- **Long-term** (over one week): pH 4 buffer solution with 1 g per 100 mL of potassium chloride (KCl) added.

Pressure

This component of the multi-sensor measures absolute gas pressure from 0 kPa to 700 kPa. The measurement can be displayed in units of kPa, N/m^2 , pounds per square inch (p.s.i.), atmospheres (atm), or torr.

With nothing connected to the pressure port, the sensor measures atmospheric pressure (about 101 kPa).

To measure the pressure in an apparatus or the included syringe, connect it to the sensor using the included tubing and connectors. Insert the barbed end of a quick-release connector into a piece of tubing. Push the quick-release connector onto the sensor's pressure port and twist it clockwise to secure it. If your apparatus has a barbed or tapered connector (such as the included syringe), plug it directly into the other end of the tubing. If the apparatus has a quick-release pressure port, use another quick-release connector on the other end of the tubing. Use one of the included tubing connectors to connect the tubing to larger-diameter tubing or to a rubber stopper with a hole.

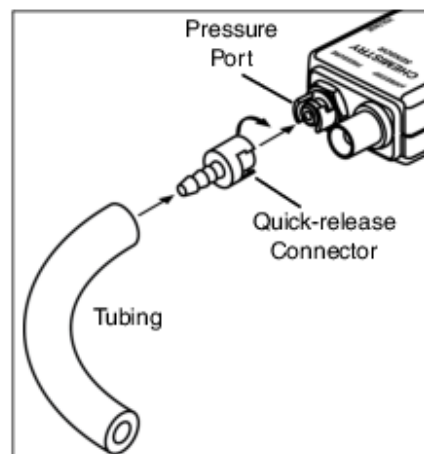

Note: Do not allow liquid to enter the pressure port.

Voltage

Use the voltage component of the multi-sensor to measure electric potential difference between the terminals of a battery or power supply, or two points on a circuit. The voltage probe has two connectors: red and black, and two alligator clips with insulators. The sensor measures the voltage of the red connector in reference to the black connector. Its range is ± 10 V.

Specifications

General	
Component Sensors	Temperature, pH/ISE/ORP probe voltage, Absolute Pressure, Voltage
Max. Sampling Rate	100 samples per second (for each component sensor)
Default Sampling Rate	10 samples per second
Temperature	
Range	-35 °C to +135 °C
Accuracy	± 0.5 °C
Resolution	0.01 °C or better
Sensing Element	10 k Ω thermistor located in probe tip
pH/ISE/ORP probe voltage	
Electrode Connector	standard BNC
Voltage Range	-2000 mV to +2000 mV
Voltage Resolution	0.1 mV
pH Range	0 to 14
pH Resolution	0.001
Absolute Pressure	
Range	0 kPa to 700 kPa
Accuracy	2 kPa
Resolution	0.1 kPa
Repeatability	1 kPa

Voltage	
Range	-10 V to + 10 V
Accuracy	± 0.1 V
Resolution	± 0.04 mV
Voltage Protection	up to 240 V
Input Resistance	2 M Ω

Appendix A: PASCO Capstone Calibration

In PASCO Capstone, click the Hardware Setup icon in the tools palette to open the Hardware Setup panel. Confirm that the icon of the sensor appears with the icon of the interface being used. Click the Hardware Setup icon again to close the panel. Click the Calibration icon (🔧) in the Tools palette to open the Calibration panel. For a two-point calibration, you will need two “known standards,” such as two buffer solutions of known pH or two liquids of known temperature, such as ice water and hot water. For temperature calibration, a standard thermometer will also be needed.

1. The first step in the Calibration panel is to choose the type of measurement you would like to calibrate. The default for the Chemistry sensor is “Temperature”. The other choice on the menu is “pH”. Click “Next”.
2. In the second step, the temperature probe is automatically selected (if the default measurement is kept). Move to the third step.
3. The third step in the panel is to choose the type of calibration “Two Standards (2 point)” is the default. Click “Next”.
4. The fourth step in the panel is to calibrate the first point. The “Standard Value” shows 0.00 °C. (This Standard Value can be changed if necessary. Highlight the “Standard Value” and enter a new value if needed). For this example, put the temperature probe into a “known standard” of ice water. Click “Set Current Value to Standard Value” and then click “Next”.
5. The fifth step in the panel is to calibrate the second point. The “Standard Value” shows 100 °C. For this example, put the temperature probe into a “known standard” of hot water along with the thermometer. Highlight the “Standard Value” and enter the temperature from the thermometer. Click “Set Current Value to Standard Value” and then click “Next”.
6. The sixth step in the panel is to review and accept the calibration information. Click “Back” to return to a previous step. Otherwise, click “Finish”. The first step in the panel appears again. Follow the same procedure to calibrate for another type of measurement.
7. Click the Calibration icon in the Tools palette to close the Calibration panel.

The screenshot shows the 'Calibration' panel in PASCO Capstone. It is divided into six numbered steps:

- Step 1:** 'Choose the type of measurement you would like to calibrate:'. A dropdown menu shows 'Temperature' selected.
- Step 2:** 'Choose the probes you would like to calibrate now:'. A list shows 'Temperature Measurements' with a sub-entry 'Chemistry Sensor, Ch P1: Temperat' selected.
- Step 3:** 'Choose the type of calibration you would like to perform:'. Radio buttons are shown for 'Two Standards (2 point)', 'One Standard (1 point offset)', 'One Standard (1 point slope)', 'Restore Factory Calibration', and 'Review Current Calibration'. 'Two Standards (2 point)' is selected.
- Step 4:** 'Calibrate the first point:'. It shows 'Standard Value' as 0.00 °C and 'Current Value' as 0.152 °C. A button 'Set Current Value to Standard Value' is visible.
- Step 5:** 'Calibrate the second point:'. It shows 'Standard Value' as 100 °C and 'Current Value' as 99.9 °C. A button 'Set Current Value to Standard Value' is visible.
- Step 6:** 'Review your calibration and accept:'. It displays a table of calibration data for 'Chemistry Sensor, Ch P1'.

At the bottom of the panel are buttons for 'Back', 'Finish', and 'Cancel'.

Chemistry Sensor, Ch P1		
Temperature		
Old Calibration		
Slope	1.00	°C/Units
Offset	0.00	Units
Live Value	76.6	°C
New Calibration		
Slope	1.30	°C/Units
Offset	-1.23	Units
Live Value	96.1	°C

Appendix B: SPARKvue HD Calibration

You can use the SPARKvue HD software if you are using the Chemistry MultiMeasure Sensor with a PASPORT-compatible interface connected to a computer, or with a mobile device paired with a PASCO wireless interface, such as the AirLink2 or SPARKlink Air.

If the sensor is connected to a PASPORT-compatible interface, start the SPARKvue software on the computer. If the sensor is connected to a SPARK SLS interface, start the interface.

For a two-point calibration of the Temperature probe, you will need two “known standards,” such as two liquids of known temperature, such as ice water and hot water. A standard thermometer will also be needed.

After startup, the screen will show the list of measurements for the Chemistry Sensor.

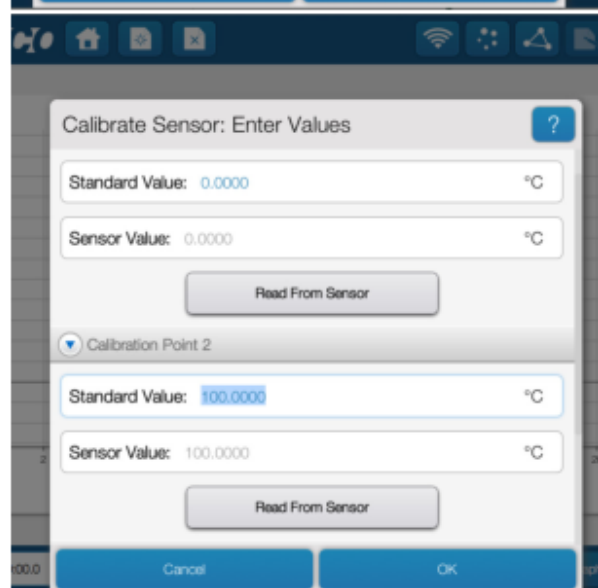
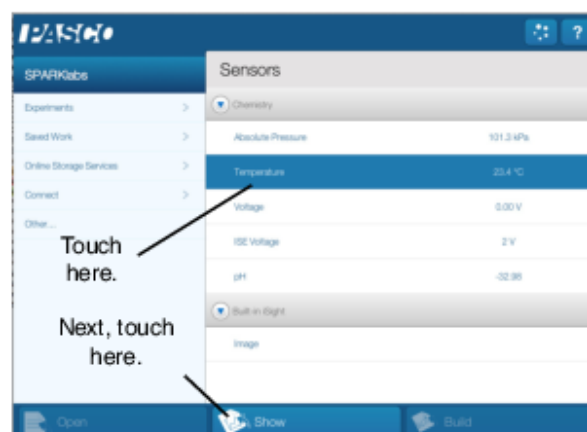

1. Touch “Temperature” and then touch “Show”.
 - The screen will show a Graph display of temperature and time.
2. Touch the “Experiment Tools” icon (⊗) in the Graph display screen to open the Experiment Tools menu. In the Experiment Tools menu, touch “Calibrate Sensor”.
 - The screen will show “Calibrate Sensor: Select Measurement”. The Sensor (Chemistry), Measurement (Temperature (°C)), and Calibration Type (2 point) are already selected.
3. Click “Next” to open the “Calibrate Sensor: Enter Values” screen.
4. The Calibration Point 1 “Standard Value” shows 0.0000 °C. (This Standard Value can be changed if necessary. Highlight the “Standard Value” and enter a new value if needed). For this example, put the temperature probe into a “known standard” of ice water. Wait a few moments. Click “Read From Sensor”.
 - The screen of the Graph display returns.
5. The Calibration Point 2 “Standard Value” shows 100.0000 °C. For this example, put the temperature probe into a “known standard” of hot water along with the thermometer. Wait a few moments and read the temperature on the thermometer. Highlight the “Standard Value” and enter the temperature from the thermometer. Next, click “Read From Sensor” and then click “OK”.
 - Follow the same procedure to calibrate pH. Use two buffer solutions of known pH value, such as pH 4 and pH 7.



Appendix C: SPARK SLS Calibration

For a two-point calibration of the pH Probe, you will need two “known standards,” such as two buffer solutions of pH 4 and pH 7. If the sensor is connected to a SPARK SLS interface used as a standalone data-logger, start the interface.

After startup, the SPARK SLS screen will show the list of measurements for the Chemistry Sensor.











- For this example, touch “pH” and then touch “Show”.
 - The screen will show a Graph display of ‘pH’ and Time.
- Touch “Experiment Tools” () to open the Experiment Tools screen.
- In the Experiment Tools screen, touch “Calibrate Sensor” to open the Calibrate Sensor screen. The screen shows the Sensor (Chemistry), the Measurement (the default is “Temperature”), and the Calibration Type (2 point (Adjust Slope and Offset)). Touch “Temperature” and then touch “pH” from the menu to change the Measurement. Touch “Next” to open the “Calibrate Sensor: Enter Values” screen.
- For Calibration Point 1, place the sensor’s probe into the first “known standard”, such as the pH 4 buffer solution. Wait a few moments and then touch “Read From Sensor”. Carefully rinse the probe in distilled water.
- For Calibration Point 2, touch the down arrow () to scroll down to the bottom of the screen. Place the probe’s sensor into the second “known standard”, such as the pH 7 buffer solution. Wait a few moments and then touch “Read From Sensor”. Rinse the probe in distilled water.
- Click “OK” until the screen of the Graph display returns.



Appendix D: Xplorer GLX Calibration

For a two-point calibration of the pH Probe, you will need two “known standards,” such as two buffer solutions of pH 4 and pH 7.

If you are using the Chemistry Sensor with the Xplorer GLX in standalone mode, connect the sensor to one of the ports on the top of the Xplorer GLX and turn the interface on.

- Optional: Go to the Home Screen (), Press F4 () to go to the Sensors screen. Use the down arrow () and the “Check” button () to change the visibility of the measurements as needed.
- Press F4 () again to open the Sensors menu. Use the down arrow () to select “Calibrate” and press “Check” ().
 - The Calibrate Sensors screen shows the sensor (Chemistry) and the default Measurement (Temperature (°C)). Use the down arrow () to select “Temperature”. Press “Check” () to change the measurement to “pH”. The Calibration Type should be “2 Point”. (If not, use the down arrow to highlight “Calibration Type” and press “Check” () to select “2 Point” from the menu.)

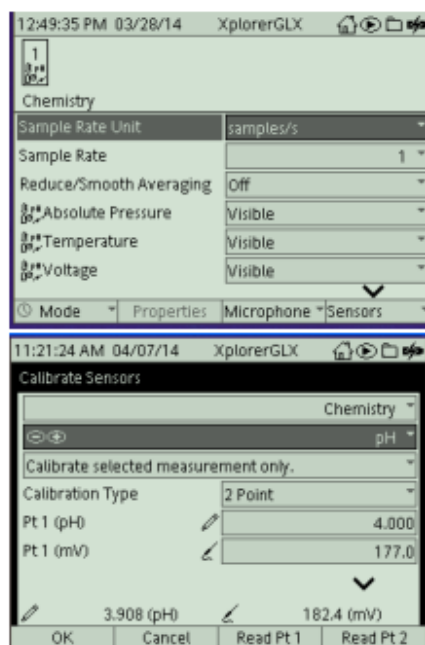

- Use the down arrow (∇) to highlight "Pt 1 (mV)". (NOTE: If you need to change the Standard Value, highlight Pt 1 (pH), press "Check", and use the keypad to enter the correct Standard Value.)
- Put the Chemistry Sensor's pH Probe into the first "known standard" (pH 4 buffer solution). Wait a few moments and then press F3 ($F3$) to "Read Pt 1".
- Use the down arrow to scroll down to the second calibration point, Highlight "Pt 2 (mV)". Put the Chemistry Sensor's pH Probe into the second "known standard" (pH 7 buffer solution). Wait a few moments and then press F4 ($F4$) to "Read Pt 2".
- Press F1 ($F1$). "OK", to return to the Sensors screen.
- In the Sensors screen, press \leftarrow to return to the Home Screen.

