

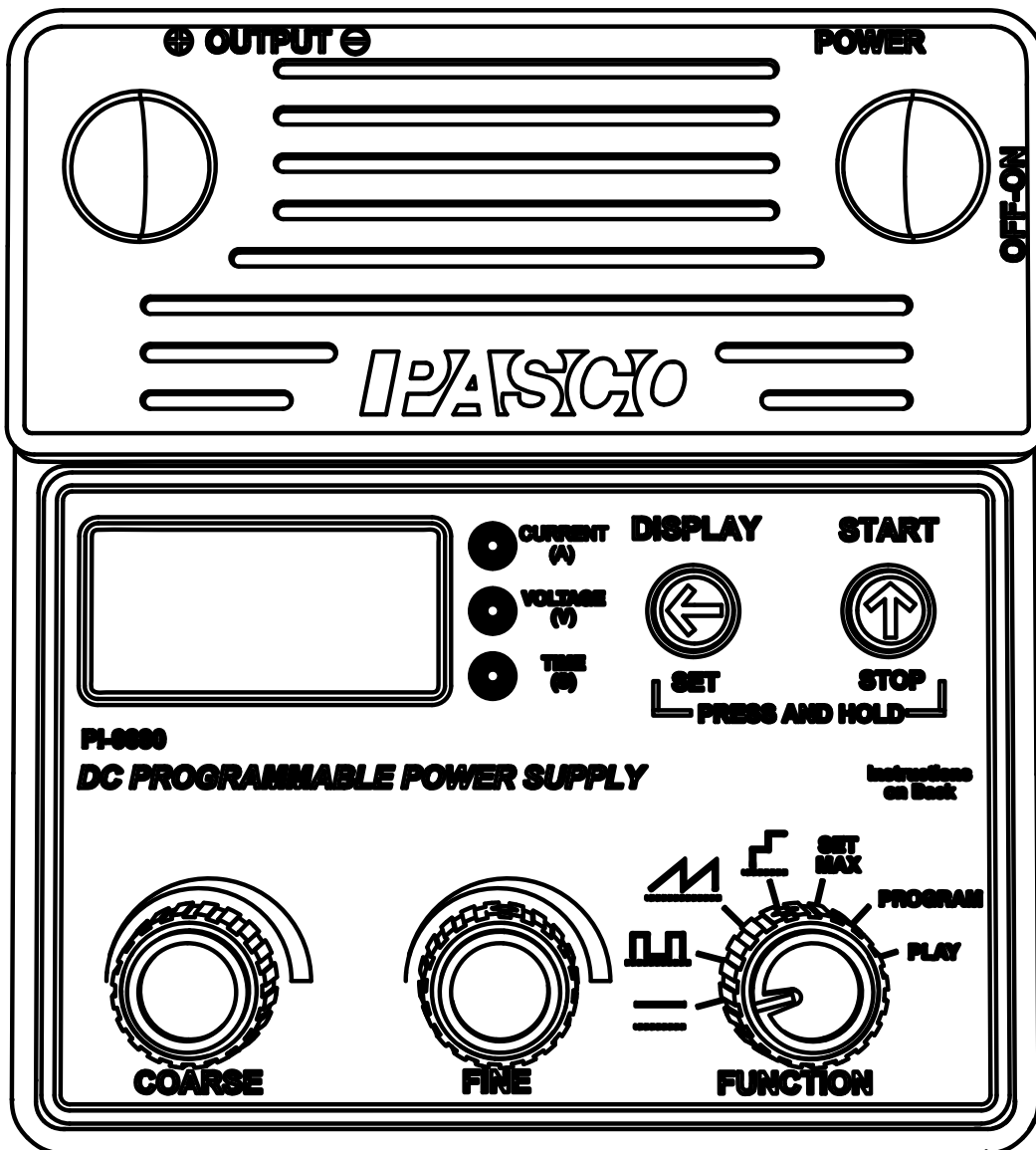

DC Programmable Power Supply

PI-9880



Contents

Introduction	3
Typical Uses	4
Specifications	4
Tutorial	7
Basic Operation	19
Standard Functions (Rectangle, Ramp, and Stair)	22
Custom Program	28
Technical Support	35

DC Programmable Power Supply

PI-9880

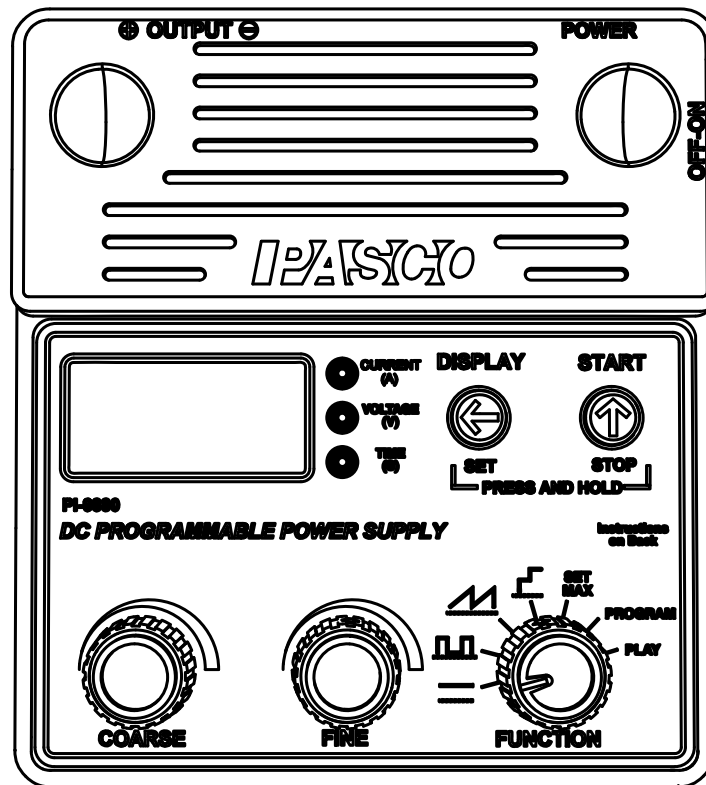

Included Equipment	Part Number
DC Programmable Power Supply	PI-9880
AC Power Adapter (100 - 240 VAC, 24 VDC)	540-102

Introduction

The PI-9880 DC Programmable Power Supply sources 0–18 volts (V) at up to 1 ampere (A). You can use the Power Supply as a simple constant-voltage source, or take advantage of its advanced features to output periodic functions and custom programs.

Typical Uses

The Programmable Power Supply works well with a variety of electronic circuits, motors, lamps, heaters, and Peltier devices, and the PASCO apparatus listed below.

Model Number	Name	Comments
ET-8499	Calorimeter	Set the Power Supply's Stair function for a single heat pulse (see page 26).
EM-8678	Charge/Discharge Circuit	Use the Power Supply to charge the circuit's capacitor or battery. Set the Power Supply's maximum voltage to 5 V (see page 20).
ET-8782	Thermoelectric Circuit	Set the Power Supply's maximum voltage to 10 V (see page 20).
ME-8088	Centripetal Force Apparatus	Use the Power Supply's ramp function (see page 23) to slowly increase the rotational speed.
ME-8750	Mechanical Oscillator Driver	Drive dynamics carts (such as ME-6950) or the Chaos/Driven Harmonic Accessory (CI-6689A).
ME-8955	Rotational Motor Drive	Drive the Rotating Platform (ME-8951) with the Magnetic Levitation Accessory (EM-8947) or Rotational Acceleration Tank (ME-8957).
TD-8513	Heat Conduction Apparatus	Power the apparatus with a positive-offset rectangle wave (see page 22) or sine wave (the Power Supply's default custom program, see page 28).

Specifications

General Specifications	
Output Voltage Adjustment	0–18 V
Voltage Adjust Resolution	10 mV
Voltage Adjust Accuracy	0.25% of setting or 20 mV, whichever is larger
Current-limit Shutdown	Programmable, 0.010–1.050 A
Current Measurement Accuracy	3%
Load Regulation	1%
Output Noise	20 mV peak-to-peak typical, 60 mV peak-to-peak at full load
Function-specific Specifications	
Function 1: Constant DC Output (see page 19)	Monitor voltage or current, or cycle with adjustable time
Function 2: Rectangle Wave (see page 22)	Programmable maximum voltage Programmable minimum voltage Programmable period: 0.1–999 s Programmable duty cycle: 1–99%, Jitter: $\pm 300 \mu\text{s}$ Monitor voltage or current
Function 3: Ramp (see page 23)	Programmable maximum voltage Programmable minimum voltage Programmable period: 0.1–999 s Programmable ramp direction (ascending or descending) Alternating ramp direction option (triangle wave) Programmable number of cycles: 1 to 999, or infinite Monitor voltage or current

Function 4: Stair (see page 25)	Programmable maximum voltage Programmable step voltage: 0.01–18.00 V Programmable minimum voltage Programmable step time: 0.1–999 s Programmable stair direction (ascending or descending) Alternating stair direction option Programmable number of cycles: 1 to 999, or infinite Monitor voltage or current
Function 5: SET MAX (see page 20)	Programmable voltage limit: 0.01–18.00 V Programmable maximum current: 0.010–1.050 A Automatic shutdown timer: 0.01–99.99 hours “Hidden” Global Maximum voltage: 0.01–18.00 V (remembered after power off)
Function 6: PROGRAM Custom program entry (see page 28)	3–99 programmable voltage points (remembered after power off) Edit modes: append, insert, delete point, delete entire program
Function 7: PLAY Custom program output (see page 29)	Programmable scale factor: 1–100% of programmed voltage Programmable step-time: 0.1–999 s Step-style and vector-style options Programmable play direction (forward or backward) Alternating play direction option Programmable number of cycles: 1 to 999, or infinite Monitor voltage or current

Combining Two Units Two or more Programmable Power Supplies can be connected *in series*. Connect the negative terminal of one unit to the positive terminal of the other.



Excessive voltage levels can be achieved when combining units in this way; students should do so only under the supervision of a qualified instructor.

Storage For easy storage of multiple units, indentations in the Programmable Power Supply accept the feet of an identical unit stacked on top of it.

Experiment-design Considerations Please note the following properties of the Programmable Power Supply when planning an application:

- The Power Supply is over-current protected, but it is not current-limited or current-regulated. If the maximum output current (1 amp by default, or lower if you have changed the maximum-current setting) is exceeded, the Power Supply will need to be manually reset before operation can resume. See “Over-current” on page 20.
- The output voltage range is 0 to 18 V. To achieve a negative voltage switch the positive and negative leads.
- This device is a programmable power source, not a function generator. The maximum frequency of the rectangle and ramp functions is 10 Hz. The maximum frequency of the default sine-wave custom program is about 0.1 Hz.
- The Power Supply is designed for current flow in one direction: out of the positive terminal and into the negative terminal. In the example illustrated below, the Power Supply is switched from 0 V to 5 V, then back to 0V. The capacitor does not discharge in a predictable way because there is not a simple path to ground.

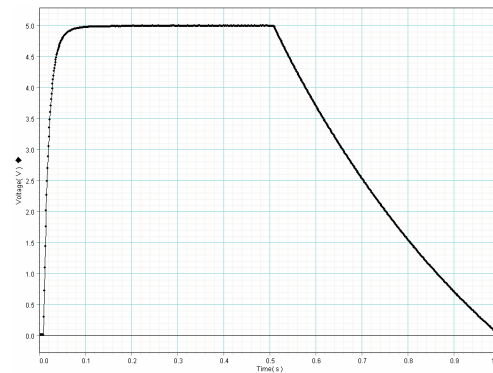
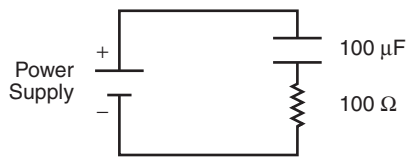

To provide a path to ground, connect a resistor across the Power Supply's terminals as shown.

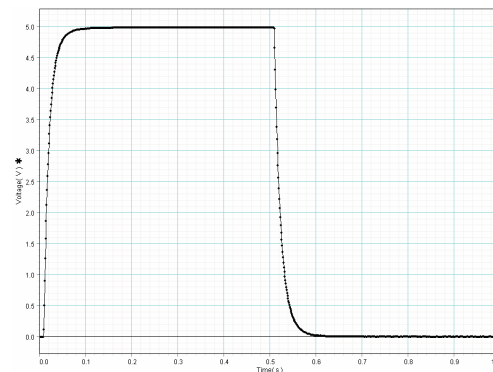
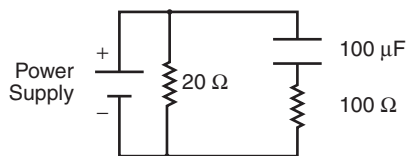

A current-sinking resistor is not typically required when driving motors, lamps and heating resistors since these devices have a low DC resistance.



Tutorial

This tutorial will introduce you to the DC Programmable Power Supply. As you follow the steps, it will be helpful to measure and view the Power Supply's voltage output. Here are three possible ways to do that:

1. Use a data-acquisition program such as DataStudio with a voltage sensor. The sample waveforms shown in the tutorial were collected in this manner.
2. Use an digital storage oscilloscope capable of displaying several second's worth of data.
3. Use a normal volt meter. This option will not allow you to reproduce the graphs on the following pages, but you will be able to observe the variation of the Power Supply's output.

If possible, connect a load resistor (or other device such as a small light bulb) to the output so that you can look at the current draw. You can use any resistor from about $20\ \Omega$ to $100\ \Omega$, but check the power rating to make sure it will not overheat; during the tutorial, you will apply voltages up to 10 volts.

Set-up

1. Plug the AC adapter into a wall outlet and into the port labeled POWER on the Power Supply.
2. Use a pair of banana-plug patch cords to connect a load resistor (or other device) to the Power Supply's red (+) and black (-) OUTPUT ports.
3. Connect a voltage sensor, meter, or oscilloscope to the OUTPUT ports.
4. Notice the two buttons:  and . You will use these buttons, along with the knobs, to control the Power Supply's output and display.
5. Push *and hold both* buttons. While holding the buttons, turn on the power switch (if it is already on, turn it off and on again). Continue to hold both buttons until the display shows **LLLL**, then release the buttons. The original factory settings have been loaded.



POWER and OUTPUT connections

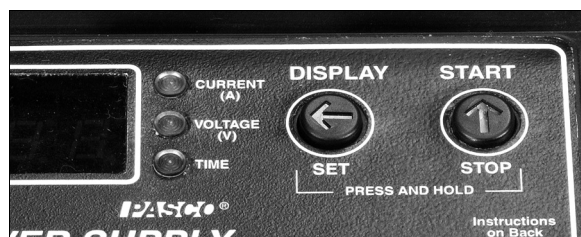

Buttons



Load factory settings

Function 1: DC Voltage

1. Turn the Function knob to the Constant DC position (.....). The display briefly shows **F1** (for "Function 1"), then **0.00** (for zero volts). The Voltage LED is lit, indicating that the quantity displayed is voltage in units of volts.

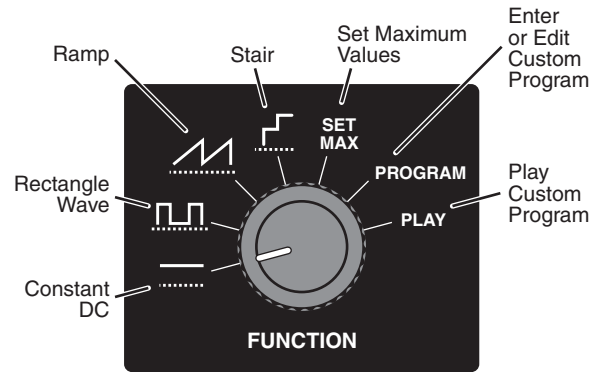

The Function knob

2. Turn the Coarse knob to set the voltage to 4.00 V. Note that the displayed voltage reflects the actual voltage at the output terminals.

Turn the Fine knob. If you rotate it slowly, the voltage changes by 0.01 V per detent. If you rotate the knob more quickly, it changes by 0.04 V per detent. Adjust the voltage back to 4.00 V.

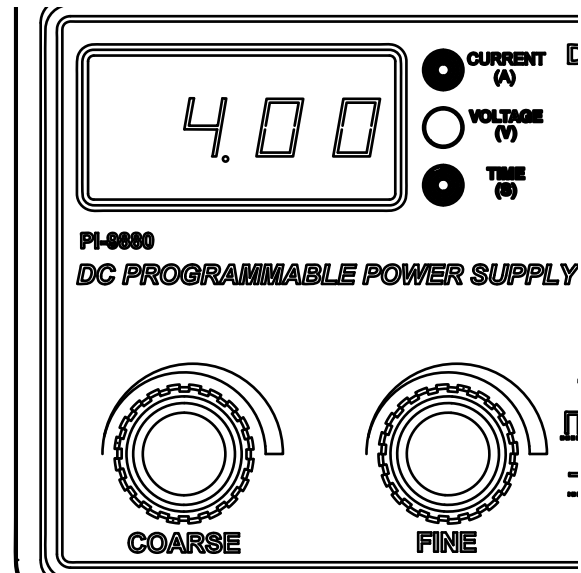

Set voltage

3. Quickly press and release  to temporarily switch off the output. The Voltage LED blinks rapidly, and the actual output voltage drops to zero, though the display still shows the voltage setting.

Turn the Coarse knob. Note that you can adjust the voltage setting while the actual output remains zero. Return the voltage setting to 4.00 V

Press  to switch the output back on. The Voltage LED is now on steadily to indicate that the output voltage is live.

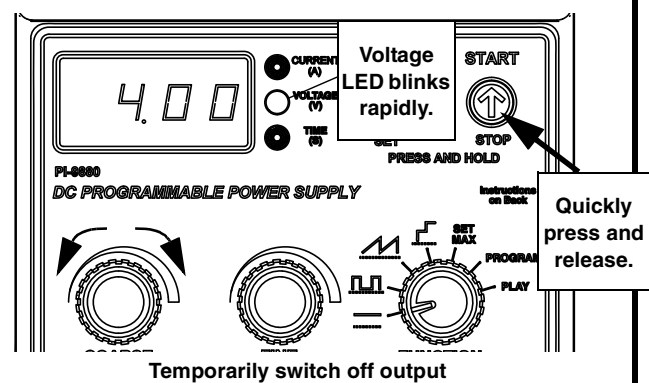

Temporarily switch off output

- Quickly press and release . The Current LED lights, and the display now shows output current in amps. Press a few times to toggle the display between current and voltage.

While viewing current on the display, turn the Coarse and Fine knobs. You are actually adjusting the voltage, but you see the resulting current change on the display.

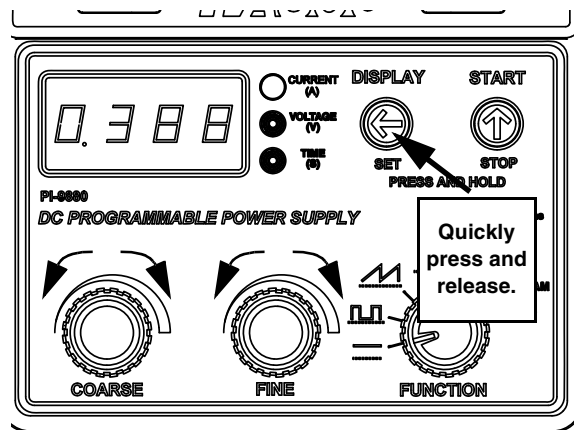

Change display

- Press *and hold* until the Time LED starts blinking, and the display shows 0; *while holding* the button, turn the Coarse knob to change the display to 2. Release the button. The display now automatically toggles between current and voltage every 2 seconds.

Press to pause the display toggling; press again to resume.

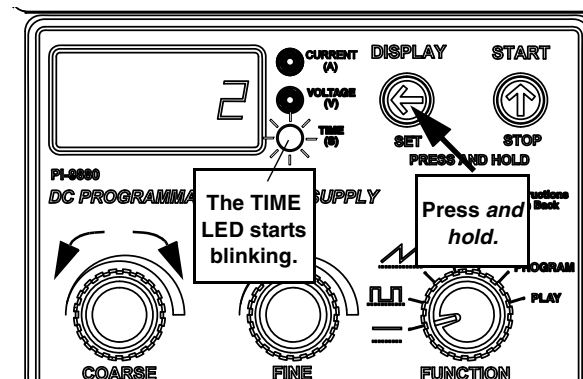

Set display-toggle time

- Press *and hold* until the display shows 0.00. Release the button. You have just reset the output voltage to zero and the display to voltage.

For more information about constant DC output, see page 19.

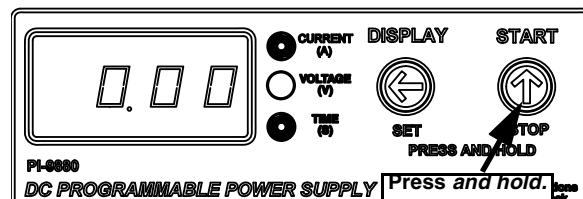

Reset output and display

Function 5: SET MAX

- Turn the Function knob to SET MAX. The display briefly shows F5 (for “Function 5”) followed by 18.00, which is the Power Supply’s voltage-limit setting. (Note that the actual output voltage is zero.)

Turn the Coarse knob to set the voltage limit to 10 V.

Turn the Function knob back to Constant DC mode (.....). Try to adjust the output voltage to over 10 volts.

- Turn the Function knob back to SET MAX. Press once to display the maximum-current setting. Turn the Coarse and Fine knobs to adjust the maximum current to 0.210 A.

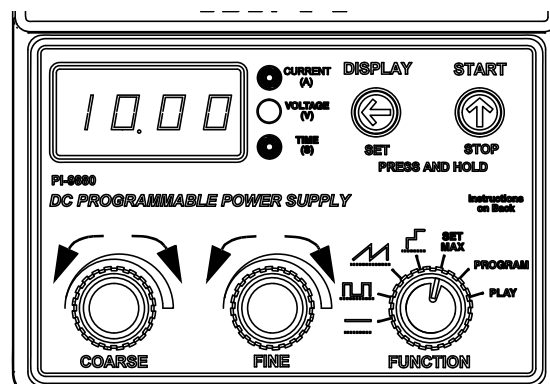

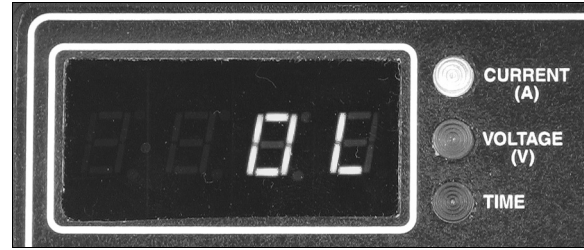

Set maximum voltage

Turn the Function knob back to Constant DC (.....). Increase the voltage until the Current LED blinks *amber* and the display shows **OL** (for “overload”) to indicate that the maximum current has been exceeded and the output has automatically turned off (this will happen only if you have a load hooked to the power supply). Press  to return the Power Supply to normal operation.





Display shows current Over Load

Turn the Function knob back to SET MAX. Press  once to display the maximum current setting. Adjust it back to 1.05 A.

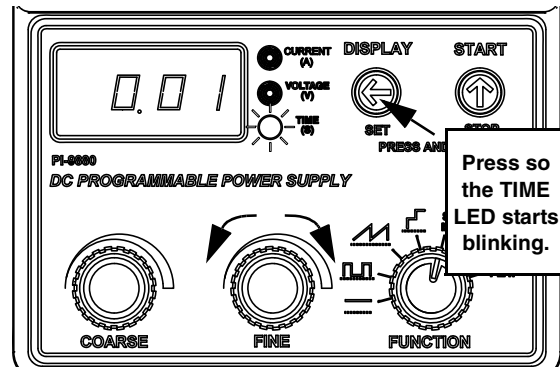
- Press  so that the Time LED starts blinking and the display shows **0.00**; this is the countdown time *in hours*. Turn the Fine knob to set the time for 0.01 hour (36 seconds). Note that the Time LED is blinking to indicate that the countdown has not started yet.



Set countdown time in hours

Press  to start the countdown. The Time LED is now lit steadily. Turn the Function knob back to Constant DC (.....) and set the voltage to 1 V. Wait for the remainder of the 36 seconds. When the countdown time has elapsed, the display shows **OFF** to indicate that the output has been switched off. Press  to return the Power Supply to normal operation.



Display shows auto off

- Turn the Function knob back to SET MAX. Push *and hold both* buttons until the Voltage LED starts blinking fast and the display shows **18.00** (this is the Global Maximum voltage setting); *while holding both* buttons, turn the Coarse knob to change the Global Maximum to 14.00 V. Release both buttons. You have just set the Power Supply so that the output voltage, the voltage-limit setting, and any other voltage setting cannot exceed 14 V.
- Repeat the previous step to turn the Global Maximum back to 18 V.

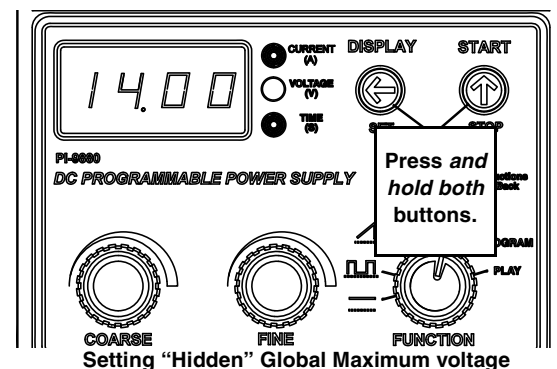

Setting “Hidden” Global Maximum voltage

For more information about setting maximum values, see page 20.

Function #2: Rectangle Wave

1. Turn the Function knob to Rectangle Wave (□). The display briefly shows **F2**, then **0.00** (the rectangle wave's maximum-voltage setting).
2. Turn the Coarse knob to set the maximum voltage to 6.00 V. Note that the actual output voltage is zero (the Voltage LED blinks to indicate that the displayed voltage is not live).
3. Press  to start running the function: a 6 V positive square wave with a 2 s period.

(Note the START label printed above the button, which indicates what happens when you press the button.)

4. Try turning the Coarse and Fine knobs; the knobs have no effect when the function is running.
5. Press *and hold*  for about 1 second to stop running the function.

(Note the STOP label printed below the button, which indicates what happens when you press *and hold* the button.)

6. Press *and hold*  (SET); the Voltage LED starts blinking fast and the display shows the minimum-voltage setting; *while holding* the button, turn the Coarse knob to adjust the minimum voltage to 2.00 V. Release the button.

Press  (START). The output voltage now alternates between 6 V and 2 V.

Press *and hold*  (STOP).

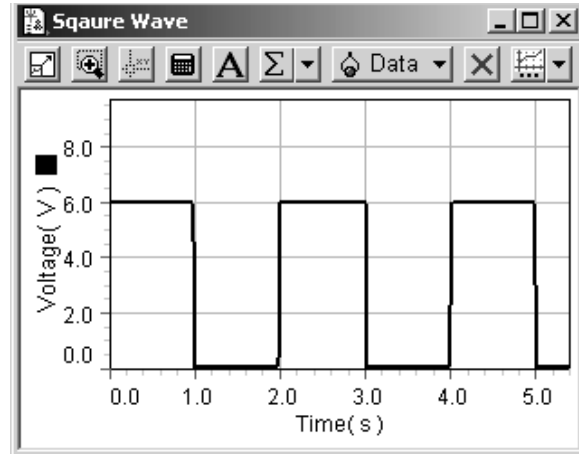

Rectangle Wave

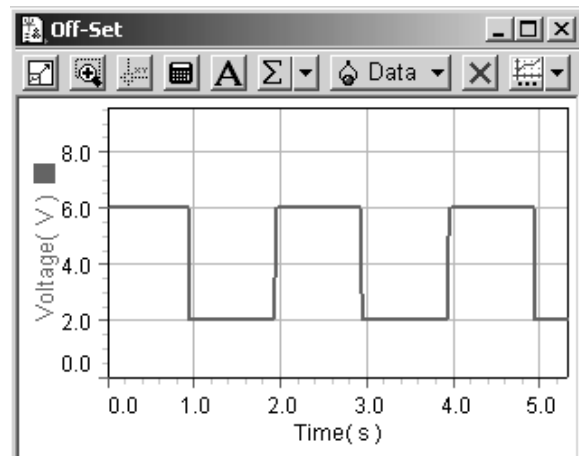

Minimum voltage set to 2 V

- Press \leftarrow . The Time LED lights and the display shows the rectangle wave's period (in seconds). Turn the Coarse and Fine knobs to change the period to 0.13 s. (By turning the Fine knob slowly you can adjust the period in 0.01 s increments.)

Turn the Coarse and Fine knobs to set the period to 3.00 s.

Press \uparrow (START). The output voltage now completes a full cycle every 3 seconds.

Press *and hold* \uparrow (STOP). Note that the display has gone back to showing the maximum-voltage setting.

- Press \leftarrow (DISPLAY) so that the Time LED is lit.

Press *and hold* \leftarrow (SET); the Time LED starts blinking and the display shows **50** (for a duty cycle of 50%); *while holding* the button, turn the Coarse knob to change the duty cycle to 10%.

Press \uparrow (START). The output voltage now spends 10% of the time at the maximum voltage and 90% of the time at the minimum voltage.

Press *and hold* \uparrow (STOP).

For more information about the Rectangle Wave function, see page 22.

Function 3: Ramp

- Turn the function knob to Ramp (\nearrow). The display briefly shows **F3**, then **18.00** (the ramp's maximum-voltage setting).
- Set the maximum voltage to 8.00 V.
- Press *and hold* \leftarrow (SET); the Voltage LED starts blinking fast and the display shows the minimum-voltage setting; *while holding* the button, adjust the minimum voltage to 2.00 V.
- Press \leftarrow (DISPLAY); the Time LED lights and the display shows the ramp's period. Set the period to 2.00 s.
- Press \uparrow (START) to run the function and observe the waveform.

Press *and hold* \uparrow (STOP).

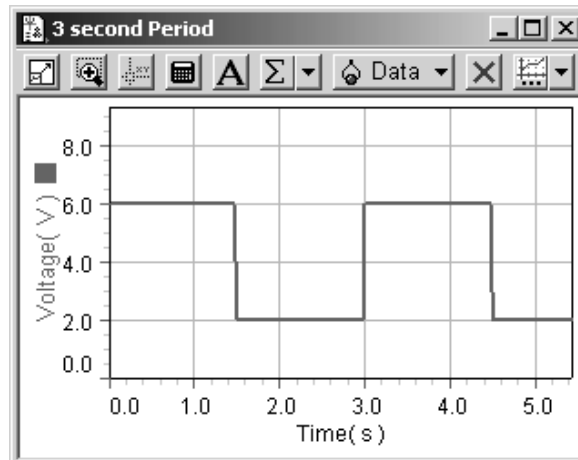

Period set to 3 s

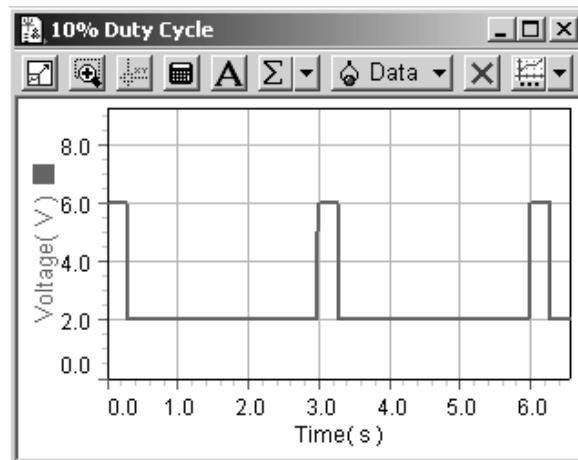

Duty cycle of 10%

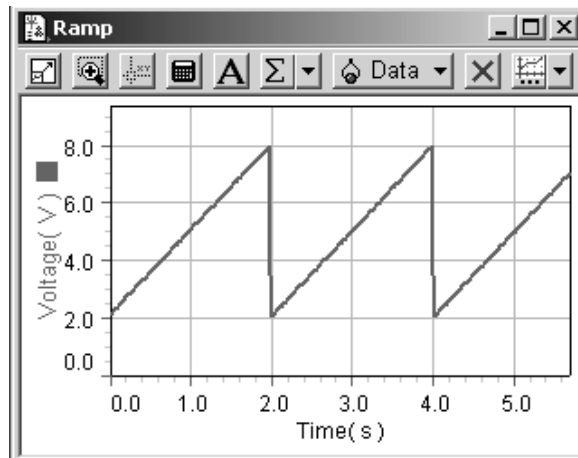

Ramp with 2 V minimum and 8 V maximum

6. Press \leftarrow (DISPLAY) to display the period. Turn the Coarse knob to set the period to -2.00 s (a negative value).

Press \uparrow (START) to run the function and observe the waveform. Note that the negative period setting makes the ramp descend.

Press *and hold* \uparrow (STOP).

Press \leftarrow (DISPLAY) to display the period again and set it back to $+2.00$ s.

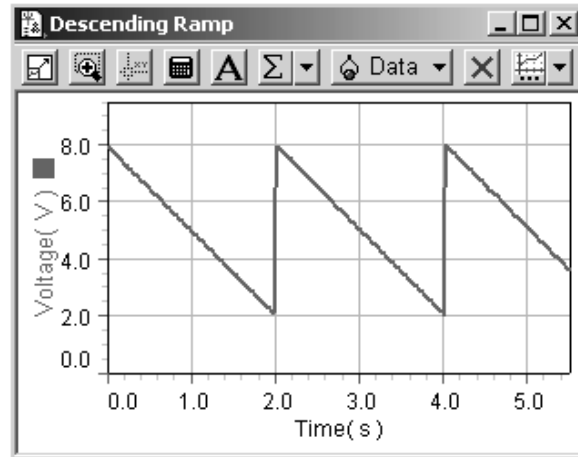

A negative period setting causes a descending ramp

7. Press *and hold* \leftarrow (SET); the Time LED starts blinking fast and the display shows 0 (the “auto-repeat” setting); *while holding* the button, turn the Fine knob to change the auto-repeat setting to 2.

Press \uparrow (START) to run the function. The output now completes two ramps and stops automatically.

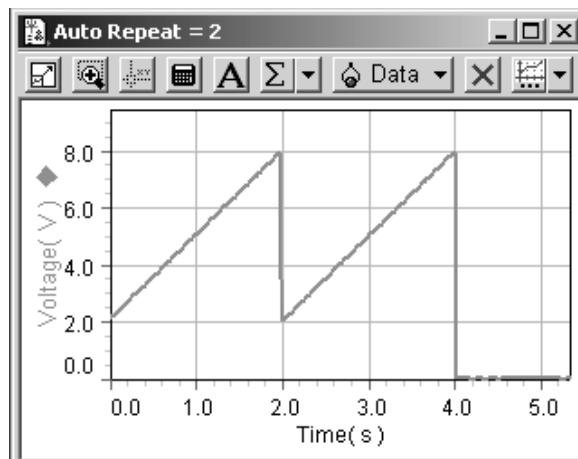

Ramp plays twice and then stops

8. Press \leftarrow (DISPLAY) so that the Time LED is lit. Press *and hold* \leftarrow (SET) and adjust the auto-repeat setting to -2 (a negative value).

Press \uparrow (START) to run the function and observe the waveform. The ramp now alternates between ascending and descending to form a triangle wave. It completes two full cycles and stops automatically.

For more information about the Ramp function, see page 23.

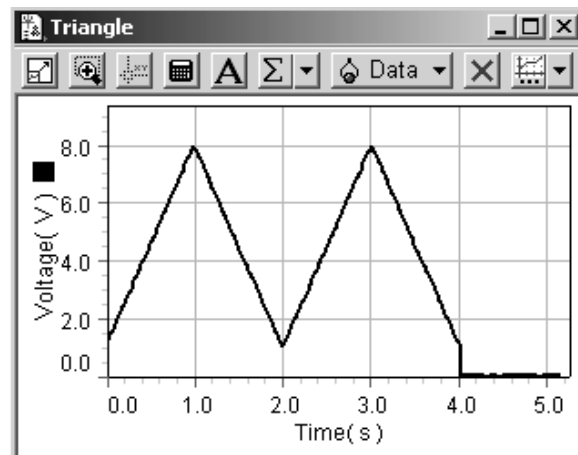

A negative auto-repeat setting causes a triangle wave

Function 4: Stair

1. Turn the Function knob to SET MAX. Set the Power Supply's voltage limit to 8 V.
2. Turn the Function knob to Stair (⌄). The display briefly shows **F4**, then **1.00** (the voltage-step setting).
3. Press *and hold* (⏻) (SET); the Voltage LED starts blinking fast and the display shows the minimum-voltage setting; *while holding* the button, adjust the minimum voltage to 1.00 V.
4. Press (⏻) (DISPLAY) so that the Time LED is lit and the display shows the step-time setting. Set the step time to 1.00 s.
5. Press (▶) (START) to run the function and observe the waveform. Note that the top of the stair is determined by the Power Supply's voltage-limit setting.

Press *and hold* (▶) (STOP).

6. Press (⏻) (DISPLAY) so that the Time LED is lit again. Press *and hold* (⏻) (SET); the Time LED starts blinking and the display shows the auto-repeat setting; *while holding* the button, adjust the auto-repeat setting to -0 ("negative zero").

Press (▶) (START) to run the function and observe the waveform. The stair now alternates between ascending and descending.

Press *and hold* (▶) (STOP).

7. Turn the Function knob to SET MAX. Turn the Coarse knob to set the voltage limit to 18 V.

For more information about the Stair function, see page 25.

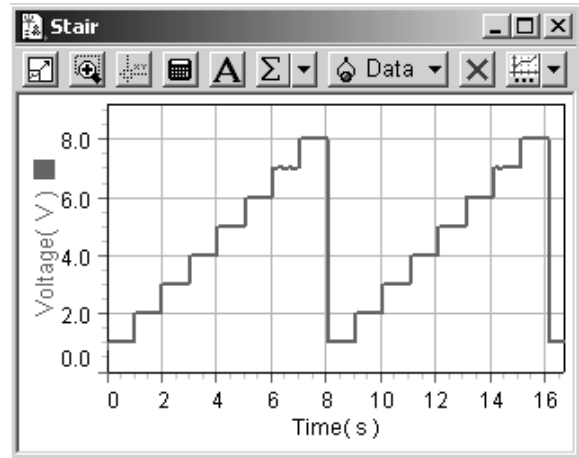

Stair

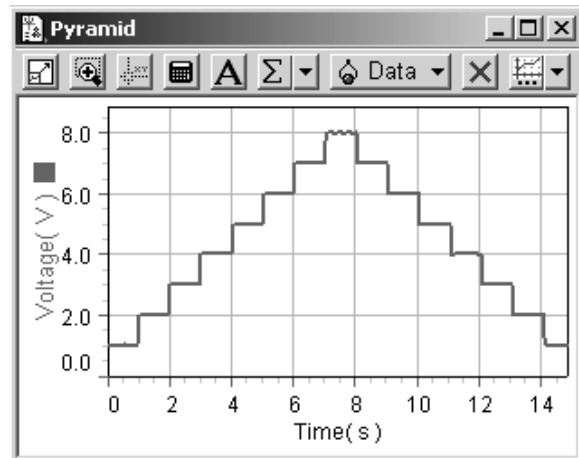

Stair with a negative auto-repeat setting

Function 7: PLAY (Custom Program)

1. Turn the Function knob to PLAY. The display briefly shows **F7**, then **100** (for a scale-factor setting of 100%).
2. Press \uparrow (START) to start playing the default custom program.

After the program has played for several seconds, press *and hold* \uparrow (STOP).

If you are using a voltage sensor, be sure to stop the program before it exceeds 10 V.

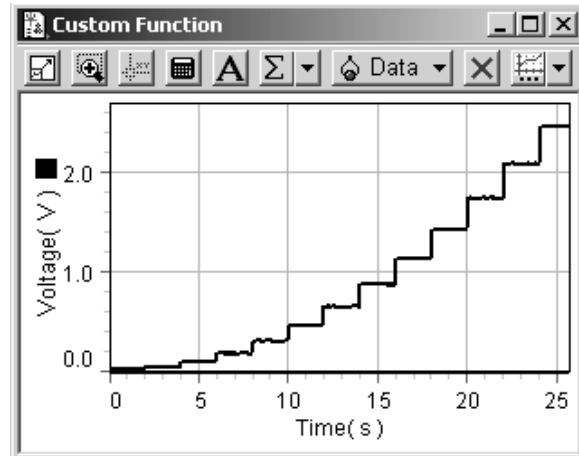

Playing stored custom program

3. Turn the Coarse knob to change the Scale Factor to 50%.

Press \uparrow (START) to play the program again; each voltage point is now half of what it was before. Press *and hold* \uparrow (STOP).

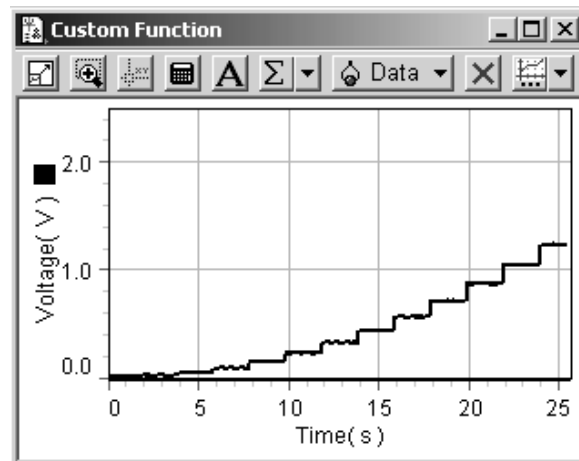

Scale Factor of 50%

4. Press *and hold* \leftarrow (SET); the display shows **1**, the graph-type setting; *while holding* the button, turn the Coarse knob to change the graph type setting to 0.

Press \uparrow (START) to play the function; the voltage ramps smoothly through the program rather than jumping from one level to the next.

Press *and hold* \uparrow (STOP).

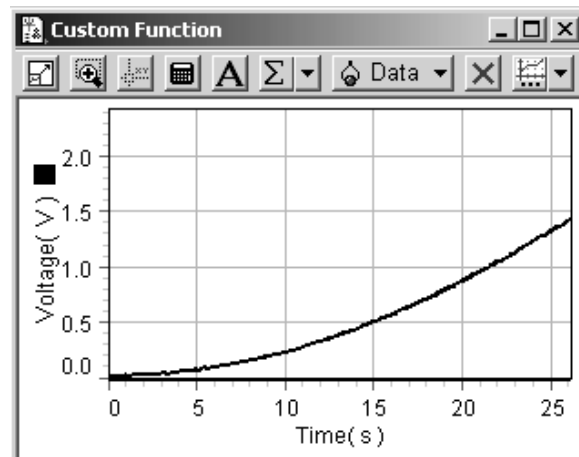

Graph type set to 0

5. Press \leftarrow (DISPLAY); the Time LED lights and the display shows the step time (or time interval between points) in seconds. Set the step time to 0.10 s.

Press \uparrow (START) to play the program; let the entire program run and stop automatically. Since there are 51 points stored in the program, the total run time is 5.1 s.

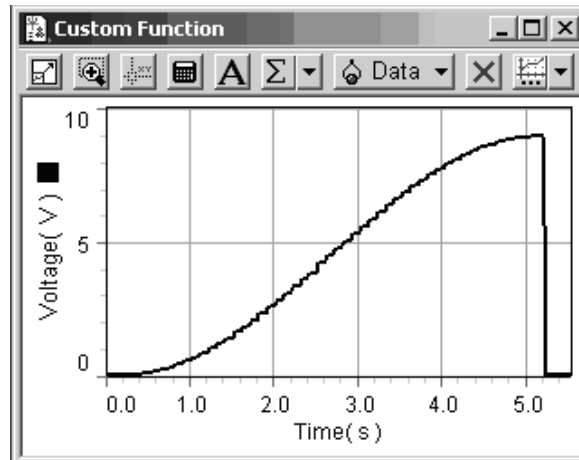

Entire program

6. Press \leftarrow (DISPLAY) to light up the Time LED again. Press *and hold* \leftarrow (SET); the Time LED starts blinking fast and the display shows the auto-repeat setting; *while holding* the button, set auto-repeat to -0 (“negative zero”).

Press \uparrow (START) to play the program again. The program now alternates between playing forward and backward resulting in a positive-offset sine wave.

Press *and hold* \uparrow (STOP).

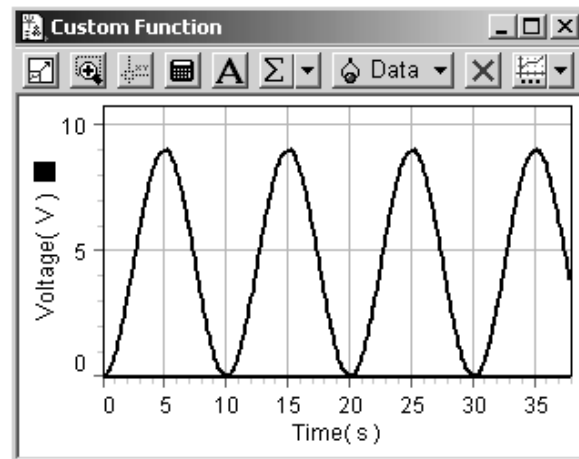

Program alternating between playing forward and backward to form a sine wave

7. Turn the Function knob to SET MAX, and set the voltage limit to 5 V. Turn the Function knob back to PLAY.

Press \uparrow (START) to play the program. The output will not exceed the voltage limit: just before the program reaches 5 V, it stops, the output voltage drops to zero, and the voltage LED flashes amber. Press *and hold* \uparrow to restore normal operation.

8. Turn the Function knob to SET MAX, and set the voltage limit back to 18 V.

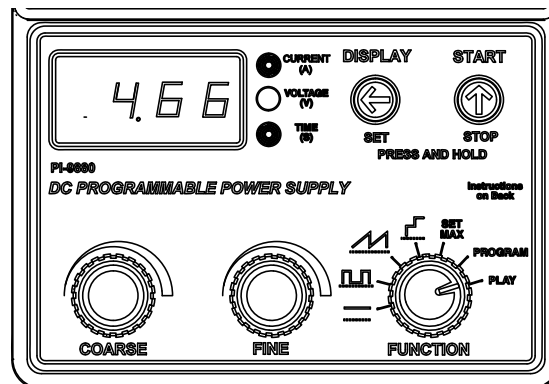

Program stops before exceeding the voltage limit

For more information about playing custom programs, see page 29.



Function 6: PROGRAM



1. Turn the Function knob to PROGRAM. The display briefly shows **F6**, then **P 51** to indicate the number of points stored in memory.



- Turn the Coarse knob one detent counter-clockwise to view one of the stored points. Turn the Coarse knob some more (a few rotations) until you see Point #10; the display shows **P 10**, then (after you stop turning the knob) it shows **1.40**, the stored voltage of Point #10.
- In this step you will delete Point #10, then insert a new point in its place with a value of 2.00 V.

Press *and hold*  to delete Point #10 (think of it as a backspace button). Release the button after you see the display flash ----.

The display now shows **1.72**, the value of what had been Point #11, but is now (temporarily) Point #10. (As shown in the third column of the table, right.)

Press . The display starts flashing, which is your prompt to set a new voltage. Turn the Coarse and Fine knobs to set the voltage to 2.00 V; then press  to store that value.

- Press *and hold*  (STOP) to exit edit mode. The display shows **P 51** to indicate the number of stored points.
- Press *and hold both* buttons simultaneously until the display shows **EEEE** (for “Erased”); release the buttons. You have just erased the stored program. The display now shows **P 0** because there are zero stored points.
- To enter a new program, press . The display starts flashing.

Turn the Coarse and Fine knobs to select a voltage for the first point; then press  to store it. Turn the knobs to select a voltage for the next point and press  to store it. Store several more points. (A program must have at least three points.)

When you are finished, press *and hold*  (STOP).

- Turn the Function knob to PLAY and press  (START) to play your new program.

For more information about entering and editing a custom program, see page 28.

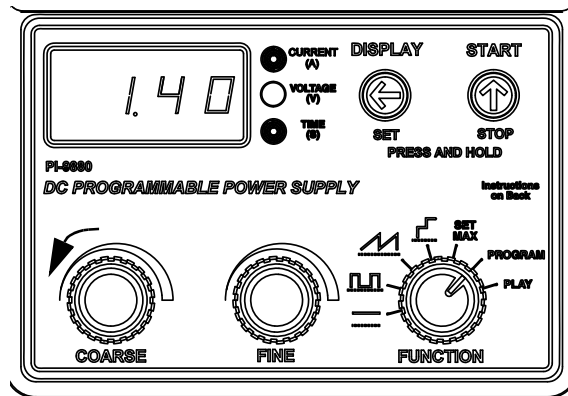

Stored point #10

Point Number	Original Program	After Deleting Point #10	After inserting a New Point
8	0.85	0.85	0.085
9	1.11	1.11	1.11
10	1.40	1.72	2.00
11	1.72	2.06	1.72
12	2.06	2.44	2.06

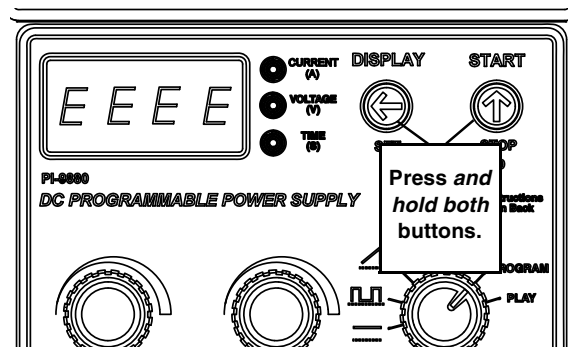

Erase the stored program

Basic Operation

Connections

Connect the included AC Power Adapter to the POWER port of the Power Supply and to a power outlet (120–240 VAC, 50–60 Hz). Slide the power switch to the ON position; when the unit is first turned on, the output voltage is zero.

Use two 4 mm banana-plug patch cords to connect the OUTPUT ports of the Power Supply to a device such as a motor, light bulb, or experimental apparatus.

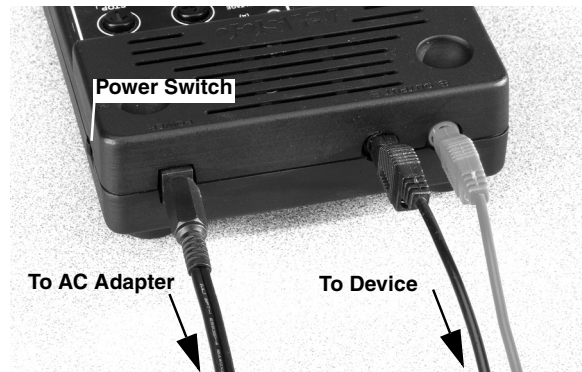

Display, Knob, and Button Overview

The Power Supply indicates its output voltage, output current, and settings on the digital display. The type of data shown on the display is indicated by the Voltage, Current, and Time LEDs. The Voltage or Current LED lights steadily when the digital display is showing the actual output voltage or current. If the Current or Voltage LED is blinking, then the actual output voltage is zero.

The Power Supply is controlled through the Function knob, the Coarse and Fine adjustment knobs, and two push buttons.

The Function knob is a rotary switch with seven positions. Each position represents a different output function or mode of operation. For simple DC output, set the knob to DC .

The Coarse and Fine knobs adjust the output voltage or the setting shown on the digital display. Rotate the Coarse knob to adjust the quantity in large steps; rotate the Fine knob to adjust it in small steps. The Fine knob is speed-sensitive: rotating it quickly causes a larger change per detent than rotating it slowly.

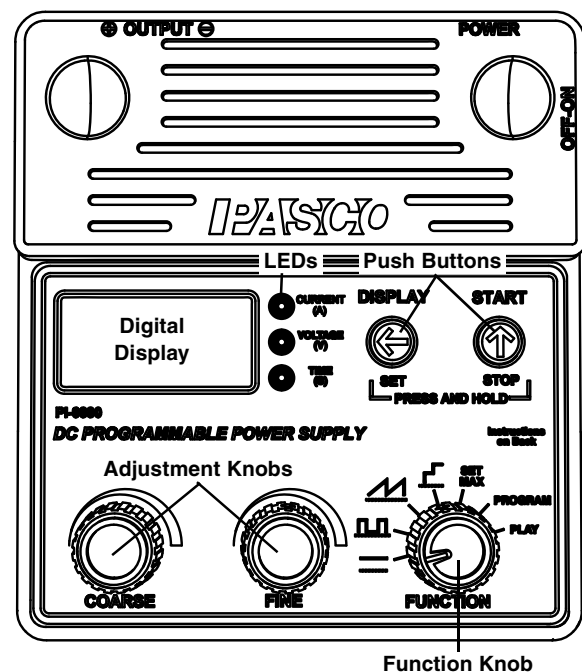

The push buttons (\leftarrow and \rightarrow) are used to select what is shown on the digital display and to control the output. In this manual you may be instructed to *press* a button, which means to press and quickly release it, or *press and hold*, which means to press it and wait for about a second before releasing it. For some operations you will press and hold a button while turning a knob; hold the button for about a second *before* you start to turn the knob and release the button after you have completed the knob adjustment. The labels above the buttons (DISPLAY and START) identify the usual function of a quick press, and the labels below (SET and STOP) the usual function of a press and hold.

Constant DC Output

Constant DC mode is the Power Supply's simplest operational mode, and the one best suited for most applications. To put the Power Supply into Constant DC mode, turn the Function knob to DC . Upon entering this mode, the output voltage defaults to zero, and the display is set to indicate voltage.

Safety Feature: Whenever the Power Supply enters Constant DC mode, the output voltage is automatically set to zero.

Set Voltage Rotate Coarse knob to change the output voltage by 1.0 V per detent; rotate the Fine knob slowly to change the voltage by 0.01 V per detent, or quickly to change the voltage by 0.04 V per detent.

By default the output voltage is limited to 18 V, but this limit may be set lower. If a load is connected to the Power Supply, the highest allowable voltage may also be limited by the maximum-current setting, which is 1 A by default. See “Maximum Values” below for instructions on setting these maximums.

Voltage and Current Display To switch the display from voltage to current, press \leftarrow (DISPLAY); the output current appears on the display, and the Current LED lights. Press \leftarrow (DISPLAY) again to switch the display back to voltage.

When current is displayed, rotating the Coarse and Fine knobs adjusts the *voltage*. Note that the current is *not* regulated. If the load changes the voltage will remain constant at its set value, but the current will change.

In Constant DC mode you can set the display to cycle between voltage and current. Press *and hold* \leftarrow (SET) while rotating the Coarse knob to set the cycle time in seconds (while you are making this adjustment, the Time LED is lit and the display shows the cycle time); then release the button. The display alternates between current and voltage at a rate determined by the cycle time that you set. Press \leftarrow (DISPLAY) to pause the display on voltage or current; press \leftarrow again to restart alternating. To disable alternating display mode, press *and hold* \leftarrow (SET) while rotating the knobs to set the cycle time to zero.

You can also press and hold \uparrow (STOP) to reset both the cycle time and the voltage to zero.

Output Switch-off To temporarily switch off the output, press \uparrow . The Voltage LED blinks quickly to indicate that the actual output voltage is zero even though the voltage *setting* (which may not be zero) is displayed. While the output is switched off, you can turn the Coarse and Fine knobs to adjust the voltage setting. Press \uparrow again to switch the output voltage back on.

Over-current If output current exceeds the maximum-current setting (see “Maximum Values” below), the output voltage drops to zero, the display reads **OL** (for “over-load”), and Current LED flashes amber. Press \uparrow (START) to resume normal operation.



Display reads OL if the maximum current is exceeded

Reset Output and Display Press *and hold* \uparrow (STOP) to set the voltage to zero and set the display to show voltage. The output and display are also reset in this way if you turn the Function knob and return it to Constant DC mode.

Maximum Values

By default, the Power Supply is set for a voltage limit of 18 V and a maximum current of 1 A. The Power Supply will not allow its output to exceed the voltage limit, and it will turn off the output if it exceeds the maximum current. To lower the maximum-allowable voltage or current, turn the Function knob to SET MAX. In this mode you can also set the Power Supply to turn off the output after a specified time.

In SET MAX mode, the display shows maximum-value *settings*; the actual output voltage is always zero.

To prevent accidental damage to lab equipment, set an appropriate maximum voltage or current for the equipment that the Power Supply will be used with.



Voltage Limit When the Power Supply first enters SET MAX mode, the Voltage LED blinks slowly and the display shows the voltage-limit setting. Rotate the Coarse knob to change the voltage limit by 1.0 volt per detent; rotate the Fine knob slowly to change it by 0.01 volt per detent, or quickly to change it by 0.04 volts per detent.



The voltage-limit setting cannot be higher than the Global Maximum voltage. See below for instructions on setting the Global Maximum.

Maximum Current Press \leftarrow (DISPLAY) to set the maximum current. The Current LED blinks slowly and the display shows the maximum-current setting (1.05 A by default). Rotate the Coarse knob to change the setting by 0.1 amp per detent; rotate the Fine knob slowly to change the setting by 0.001 amp per detent.

While the Power Supply is operating in any mode, if the output current goes over the set maximum, the output voltage will drop to zero and the Current LED will flash amber, and the display will show **OL**. Press  (START) to resume operation.

Automatic Time Off

Press  (DISPLAY) again to set the Automatic Time Off feature. The Time LED blinks and the display shows the countdown time in hours. Turn the Coarse and Fine knobs to set the time, then press  (START) to start the countdown. The Time LED is lit steadily to indicate that the countdown has started.

While the countdown is in progress, you can turn the Function knob to any position and operate the Power Supply in the normal way. To check the remaining time, return to SET MAX mode and press  (DISPLAY) twice so that the Time LED is lit. To stop the countdown (while the remaining time is displayed), press *and hold*  (STOP).

When the countdown time has elapsed, the output voltage drops to zero and the display reads **OFF**. To resume normal operation, press either button.



After setting the time, you must press  (START) to start the countdown. The maximum setting is 99.99 hours (about 4 days). You can use this feature to automatically stop an unattended demonstration or display.



Display reads OFF after Automatic Time Off

Global Maximum

The Global Maximum is a hidden feature that the instructor can use to securely set the maximum-allowable voltage. The Power Supply remembers the Global Maximum setting even after it is turned off and unplugged.

To set the Global Maximum, turn the Function knob to SET MAX. With the Voltage LED indicator blinking slowly (if a different LED is on, press  once or twice), press *and hold*  *and*  together; while holding both buttons, wait for the Voltage LED to start blinking fast, then turn the Coarse and Fine knobs to adjust the Global Maximum voltage. This master setting overrides any previous maximum voltage settings.

Safety Feature: Before giving the Power Supply to students, you can set the Global Maximum to the highest necessary voltage for the Power Supply's intended use.

Standard Functions (Rectangle, Ramp, and Stair)

The Power Supply's standard functions are simple, repeating patterns of voltage output that you can control by adjusting four or five parameters. When the Function knob is first turned to one of the standard function positions, the Power Supply goes into set-up mode: the mode in which the parameters are set. Set the parameters as instructed below, then press **START** (START) to enter run mode (described on page 29).

All of the parameters are initially set to default values when the Power Supply is turned on. Once you have set a parameter, that value remains in memory (even if you turn the Function knob to another position) until you change it or turn off the Power Supply.

Rectangle Wave

Rectangle Wave Parameters

The Rectangle Wave has four parameters: Maximum Voltage, Minimum Voltage, Period, and Duty Cycle. The Duty Cycle is expressed as a percentage of the Period, so, for instance, 50% means that the voltage is high half the time and low half the time.

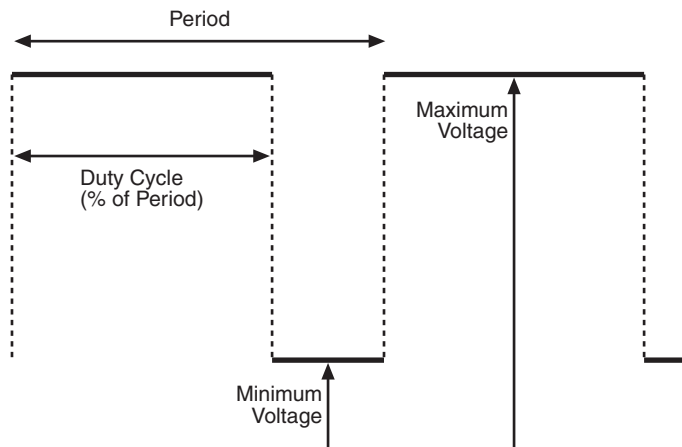

Rectangle Wave Set-up

1. Turn the Function knob to **□**. The display shows the **Maximum Voltage** parameter, and the Voltage LED blinks slowly to show that the Power Supply is in set-up mode with no output. Turn the Coarse and Fine knobs to set the Maximum Voltage.
2. To set the **Minimum Voltage**, press *and hold* **SET** (SET) until the Voltage LED starts blinking fast. While holding the button, turn the Coarse and Fine knobs. Release the button.
3. To set the **Period**, press **DISPLAY** (DISPLAY). The Time LED lights, and the display shows the Period in seconds. Turn the Coarse and Fine knobs to adjust the Period. The smallest increment by which you can change the Period depends on its value, as summarized below.

Rectangle Defaults:

Max. Voltage	0 V
Min. Voltage	0 V
Period	2 s
Duty Cycle	50%

Period (seconds)	Adjustment increment (seconds)
0.10 to 9.99	0.01
10.0 to 99.9	0.1
100 to 999	1

4. To set the **Duty Cycle**, press *and hold* **SET** (SET) until the Time LED starts blinking fast. While holding the button, turn the Coarse and Fine knobs to adjust the Duty Cycle between 1% and 99%. Release the button.

To run the Rectangle Wave, press **START** (START). See “Standard Functions Run Mode” on page 29 for further instructions.

Ramp

Ramp Parameters

The Ramp function has four parameters: Maximum Voltage, Minimum Voltage, Period, and Auto-repeat.

The Auto-repeat parameter determines the total number of cycles that are output before the function stops. For indefinite repetition, set Auto-repeat to zero.

The *signs* of the Period and Auto-repeat parameters (+ or -) determine the shape of the wave. The Period is positive for an ascending ramp or negative for a descending ramp. The Auto-repeat parameter is positive for a sawtooth wave or negative for a triangle wave, in which ascending and descending ramps alternate. Set Auto-repeat to “-0” for an indefinitely repeating triangle wave.

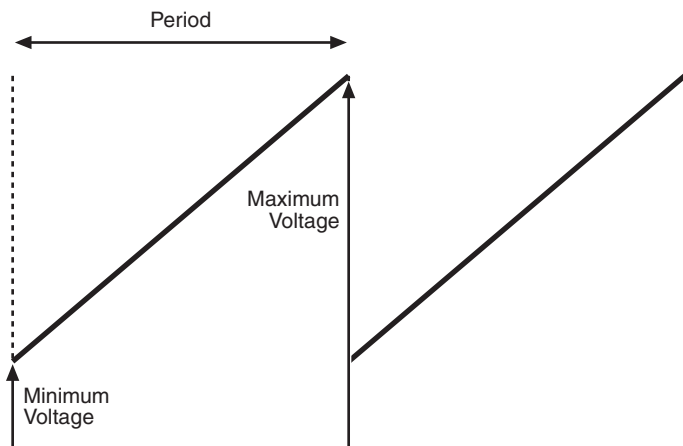

Some examples of Period and Auto-repeat settings with their resulting waveforms are illustrated below.

Period	Auto-repeat	Waveform	Comments
1.3	0		The sign of Period determines whether the ramp is ascending (+) or descending (-).
-1.3	0		Auto-repeat is set to zero for indefinite repetition.
1.3	2		The sign of Auto-repeat determines whether the wave is sawtooth (+) or triangle (-). Period and Auto repeat set the length and number of <i>full</i> cycles. For a triangle wave, a full cycle consists of an ascending <i>and</i> a descending ramp.
1.3	-2		
2.6	-2		
2.6	-0		

Ramp Set-up

1. Turn the Function knob to . The display shows the **Maximum Voltage** parameter, and the Voltage LED blinks slowly to indicate that the Power Supply is in set-up mode with no output. Turn the Coarse and Fine knobs to set the Maximum Voltage.
2. To set the **Minimum Voltage**, press *and hold* (SET) until the Voltage LED starts blinking fast. While holding the button, turn the Coarse and Fine knobs. Release the button.

Ramp Defaults:

Max. Voltage	18 V
Min. Voltage	0 V
Period	10 s
Auto-repeat	0

3. To set the **Period**, press  (DISPLAY). The Time LED lights, and the display shows the Period in seconds. Turn the Coarse and Fine knobs to set the Period. The smallest increment by which you can change the Period depends on its value, as summarized below.

Period (seconds)	Adjustment increment (seconds)
-999 to -100	1
-99.9 to -10.0	0.1
-9.99 to -0.10	0.01
0.10 to 9.99	0.01
10.0 to 99.9	0.1
100 to 999	1

4. To set the **Auto-repeat** parameter, press *and hold*  (SET) until the Time LED starts blinking fast. While holding the button, turn the Coarse and Fine knobs to adjust Auto-repeat between -999 and 999.

To run the Ramp function, press  (START). See “Standard Functions Run Mode” on page 29 for further instructions.

Stair

Stair Parameters

The Stair function has five parameters: Maximum Voltage, Step Voltage, Minimum Voltage, Step Time, and Auto-repeat.

The Auto-repeat parameter determines the total number of cycles that are output before the function stops. For indefinite repetition, set Auto-repeat to zero.

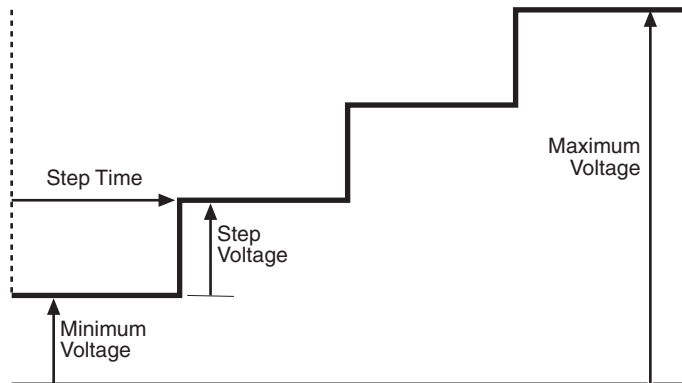

The *signs* of the Step Time and Auto-repeat parameters (+ or -) determine the shape of the wave. Step Time is positive for an ascending stair or negative for a descending stair. Auto-repeat is positive for a stair that goes in one direction (either up or down) before repeating or negative for stairs that alternate directions.

Some examples of parameter combinations and their resulting waveforms are illustrated below.

Max. Voltage	Step Voltage	Min. Voltage	Step Time	Auto-repeat	Waveform	Comments
18	5	0	1.0	1		The sign of Step Time determines whether the stair is ascending (+) or descending (-).
18	5	0	-1.0	1		
13	5	0	1.0	2		The sign of Auto-repeat determines whether the stair goes in one direction or alternates directions. When alternating, the top and bottom steps do not repeat.
13	5	0	1.0	-2		
13	2	0	1.0	1		The top of the stairs is determined by (but not necessarily equal to) the Maximum Voltage parameter.
11	2	0	2.0	1		

Stair Set-up

1. The **Maximum Voltage** parameter of the Stair function is always equal to the Power Supply's voltage-limit setting. Turn the Function knob to SET MAX; then turn the Coarse and Fine knobs to adjust the voltage limit.
2. Turn the Function knob to \square . The display shows the **Step Voltage** parameter. The Voltage LED blinks slowly to show that the Power Supply is in set-up mode with no output. Turn the Coarse and Fine knobs to set the Step Voltage.

Stair Defaults:

Max. Voltage	18 V
Step Voltage	1 V
Min. Voltage	0 V
Step Time	2 s
Auto-repeat	0

- To set the **Minimum Voltage**, press *and hold* \odot (SET) until the Voltage LED starts blinking fast. While holding the button, turn the Coarse and Fine knobs. Release the button.
- To set the **Step Time**, press \odot (DISPLAY). The Time LED lights, and the display shows the Step Time in seconds. Turn the Coarse and Fine knobs to set the Step Time. The smallest increment by which you can change the Step Time depends on its value, as summarized below.

Step Time (seconds)	Adjustment increment (seconds)
-999 to -100	1
-99.9 to -10.0	0.1
-9.99 to -0.10	0.01
0.10 to 9.99	0.01
10.0 to 99.9	0.1
100 to 999	1

- To set the **Auto-repeat** parameter, press *and hold* \odot (SET) until the Time LED starts blinking fast. While holding the button, turn the Coarse and Fine knobs to adjust Auto-repeat between -999 and 999.





To run the Stair function, press \uparrow (START). See “Standard Functions Run Mode” on page 29 for further instructions.

Special Application: Heat Pulse



For calorimeters and other apparatus that use heating resistors, you may want to drive the resistor with a pulse of a specific voltage and duration. To program a single 10 V pulse that lasts for 10 seconds, set up the Stair function with the following parameters:

Max. Voltage	Step Voltage	Min. Voltage	Step Time	Auto-repeat	Waveform
10	10	0	-10.0	1	

Standard Functions Run Mode

1. To **run** any of the standard functions, turn the Function knob to  (Rectangle Wave),  (Ramp), or  (Stair) and press  (START). The Voltage LED lights steadily to indicate that the display shows that actual output voltage. To display the output current, press .

While a function is running, the Coarse and Fine knobs are not active; parameters can be changed only in set-up mode.

2. To **pause** the function, press . The Voltage LED light blinks fast and output voltage goes to zero, though the paused voltage (which may not be zero) is shown on the display. To continue running the function, press  again.
3. To **stop** running the function and return the Power Supply to set-up mode, press *and hold*  (STOP); you can do this while the function is either running *or* paused. (The output stops automatically after the number of repetitions specified by the Auto-repeat parameter.)

If the output current exceeds the shutdown-current setting (see “Maximum Values” on page 20), the output voltage drops to zero, the display reads **OL** (for “overload”), and Current LED flashes amber. Press  (START) to return the Power Supply to set-up mode.

Custom Program

The Power Supply's custom program is a stored list of up to 99 voltage points.

The Power Supply comes pre-loaded with a positive off-set sine wave program. If you change or erase this program, your changes will be remembered even if you turn the Power Supply off. To restore the default sine-wave program: turn off the unit, press and hold *both* buttons while turning on the power switch, continue to hold both buttons until the display shows **LLLL** to indicate that the program has been **L**oaded into memory.



Enter or Edit Custom Program

To enter or edit the custom program, turn the Function knob to PROGRAM. The display shows the number of stored points (for example **P 51** if there are 51 stored points) and none of the LEDs are lit. This is Program Home mode.

When the Function knob is in the PROGRAM position, you can always press and hold  (STOP) to return to Program Home mode.

From Program Home mode you can do three things: erase the program, append the program, or edit the program.

Erase



To erase the entire program, press *and hold*  and  until the display shows **EEEE**. Release the buttons. The Power Supply returns to Program Home mode, with the display showing **P 0** to indicate that zero points are stored. Follow the Append instructions below to enter a new program.

Append

Use Program Append mode to add points to the end of the existing program, or start a new program if zero points are stored.

1. From Program Home mode, press  (START) to enter Program Append mode. The display briefly shows index number of the point that you are about to store, then the display and Voltage LED start flickering.

At any time in Program Append mode you can press  (DISPLAY) to briefly display the index number of the point that you are about to store.

2. Turn the COARSE and FINE knobs to adjust the displayed voltage to the desired value. Press  (START) to store the point. The display then briefly shows the index number of the next point before showing the voltage setting of the next (yet-to-be-stored) point. Turn the COARSE and FINE knobs to set the voltage for this point and press  (START) to store it. Repeat this step until you have stored the entire program.
3. Press *and hold*  (STOP) to return to Program Home mode. The display shows the new number of stored points.

Program Home mode:

- Function knob in PROGRAM position
- All LEDs off



Erase stored program

Program Append mode:

- Function knob in PROGRAM position
- Voltage LED flickering

Edit



Use Program Edit mode to delete and insert points in the existing program.

1. To enter Program Edit mode (from Program Home mode) turn either the COARSE or FINE knob; adjust the knob to display the index number of the point that you wish to insert in front of or delete. After you have stopped turning the knob, the display shows the set voltage of that point, and the Voltage LED lights.

At any time in Program Edit mode you can press  (DISPLAY) to briefly display the index number of the point that you are about to insert in front of or delete.

2. To **delete** the point, press *and hold*  for 2 seconds. The display briefly shows ----, then the *new* index number of the next point after the one that you just deleted, then the voltage of that point.

To delete this next point, press *and hold*  again.

3. To **insert** a new point *in front* of the selected point, press  (START). The display starts flashing and shows the voltage of the newly inserted point. Turn the COARSE and FINE knobs to adjust the displayed voltage to the desired value. Press  (START) to store the point. The display stops flashing, briefly shows the index number of the new point, and then shows the voltage of the new point.

To insert another point, turn the Coarse or Fine knob to display the index number of the point that you wish to insert in front of and repeat this step.

4. When you are finished editing the program, press *and hold*  (STOP) to return to Program Home mode.

Program Edit mode:

- Function knob in PROGRAM position
- Voltage LED on steadily

Tips for Designing a Custom Program

- Before you start entering a program, write it on paper (or generate it on a computer), in two columns, with index numbers in the first column and voltages in the second column.
- A program must have at least three points. The maximum possible number of points is 99, though 20 or fewer points are usually sufficient. The more points you enter, the more detail there is in the function; however, by taking advantage of the auto-repeat and vector-style play options (see “Play Custom Program” below), you can achieve very smooth curves with surprisingly few stored points. The number of points also affects how long or short the period of the function can be. See below for examples.
- For the largest range of adjustability in Play mode, scale your program so that its maximum voltage is 18 V. In Play mode, you can scale down the program to reduce the output voltage.

Play Custom Program

Play Parameters

Put the Power Supply into Custom Play mode to play the stored program. Four parameters determine how the Power Supply plays the program: Scale Factor, Graph Style, Step Time, and Auto-repeat.

Scale Factor is the percentage of the programmed voltages that will be output. If Scale Factor is 100%, then the actual programmed voltages are output; if Scale Factor is 50%, the actual output voltages are *half* of the programmed values.

Graph Style can equal 1 for step-style, or 0 for vector-style. In step-style, the Power Supply outputs only the programmed voltages, jumping from one voltage to the next. In vector-style, the output ramps between the programmed voltages. In the illustration (right), note the difference in total run times for the two styles.

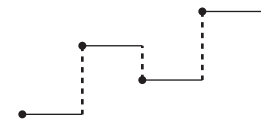

Graph Style = 1
(step-style)

Step Time sets the time (in seconds) between the programmed points. The *sign* of Step Time determines whether the program plays forward (+) or backward (-).

Auto Repeat determines the total number of cycles that are output before the program stops playing. For indefinite repetition, set Auto-repeat to zero. The *sign* of Auto-repeat determines whether the program plays in the only one direction (+) or alternating directions (-).



Graph Style = 0
(vector-style)

Some examples of parameter combinations and their resulting waveforms are illustrated below.



Scale Factor	Graph Style	Step Time	Auto-repeat	Waveform	Comments
100%	0	1.0	1		Change the Scale Factor to adjust the amplitude of the custom program.
50%	0	1.0	1		
100%	0	2.0	1		The Step Time parameter sets the time between points and thus the total length of the program. The sign of Step Time determines whether the program is played forward (+) or backward (-).
100%	0	-1.0	1		
100%	0	1.0	2		The Auto-repeat parameter sets the number of full cycles that are played. The sign of Auto-repeat determines whether the program is played in the same direction every time (+) or in alternating directions (-).
100%	0	-1.0	-1		

For a periodic or repeating function, the period depends on: the number of programmed points, the Step Time, and the sign of Auto Repeat. If Auto Repeat is negative, you only need to program the first half of the waveform because the program repeats in reverse for the second half; however, the first and last points of the program are *not*

played twice in a row, so the total number of points in a full cycle is twice the number of programmed points minus two. The table below shows some examples.

Number of Points	Step Time (s)	Auto-repeat	Period of Function (s)	Comments
20	1	0	20	The pattern is repeated every 20 seconds
21	1	-0	40	The pattern is reversed and repeated, but the first and last programmed points are not repeated.
51	0.1	-0	10	

Play Set-up

1. Turn the Function knob to PLAY. The display shows the **Scale Factor**. None of the LEDs are lit, indicating that the Power Supply is in set-up mode with no output. Turn the Coarse and Fine knobs to adjust the Scale Factor between 0% and 100%.
2. To set the **Graph Style**, press *and hold*  (SET) for about one second. While holding the button, turn the Coarse or Fine knob to select 1 (for step-style) or 0 (for vector-style). Release the button.
3. To set the **Step Time**, press  (DISPLAY). The Time LED lights, and the display shows the Step Time in seconds. Turn the Coarse and Fine knobs to set the Step Time. The smallest increment by which you can change the Step Time depends on its value, as summarized below.

Play Custom Program Defaults:



Scale Factor	100%
Graph Style	1
Step Time	2 s
Auto-repeat	1

Step Time (seconds)	Adjustment increment (seconds)
-999 to -100	1
-99.9 to -10.0	0.1
-9.99 to -0.10	0.01
0.10 to 9.99	0.01
10.0 to 99.9	0.1
100 to 999	1



Step Time is the time between points, so the total length of the program (when Graph Style is set to 1) is equal to the number of programmed steps times Step Time.

4. To set the **Auto-repeat** parameter, press *and hold*  (SET) until the Time LED starts blinking fast. While still holding the button, turn the Coarse and Fine knobs to adjust Auto-repeat between -999 and 999.

Play Custom Program

1. To **play** the custom program, turn the Function knob to PLAY and press  (START). The Voltage LED lights steadily to indicate that the display shows the actual output voltage. To display the output current, press  (DISPLAY).

While a program is playing, the Coarse and Fine knobs are not active; parameters can be changed only in set-up mode.

2. To **pause** the program, press . The Voltage LED light blinks fast and the output voltage goes to zero, though the paused voltage (which may not be zero) is shown on the display. To resume play, press  again.

3. To **stop** playing the program and return the Power Supply to set-up mode, press *and hold*  (STOP). You can do this while the program is either playing *or* paused. (The program stops automatically after the number of repetitions specified by the Auto-repeat parameter.)

If the output current exceeds the Power Supply's maximum-current setting (see "Maximum Values" on page 20), the output voltage drops to zero, the display reads **OL** (for "overload"), and Current LED flashes amber. Press  to return the Power Supply to set-up mode.

If the program calls for the Power Supply to exceed its voltage-limit setting, the program stops running, the output drops to zero, and the Voltage LED flashes amber. Press *and hold*  to return the Power Supply to set-up mode.

Example Custom Programs

The following tables show some examples of programs and settings with the resulting output.

Time Delay

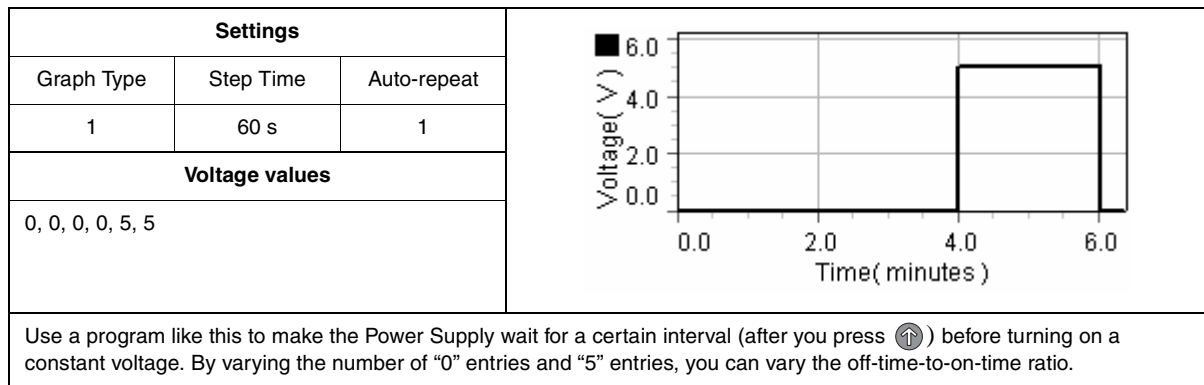

Long Ramp

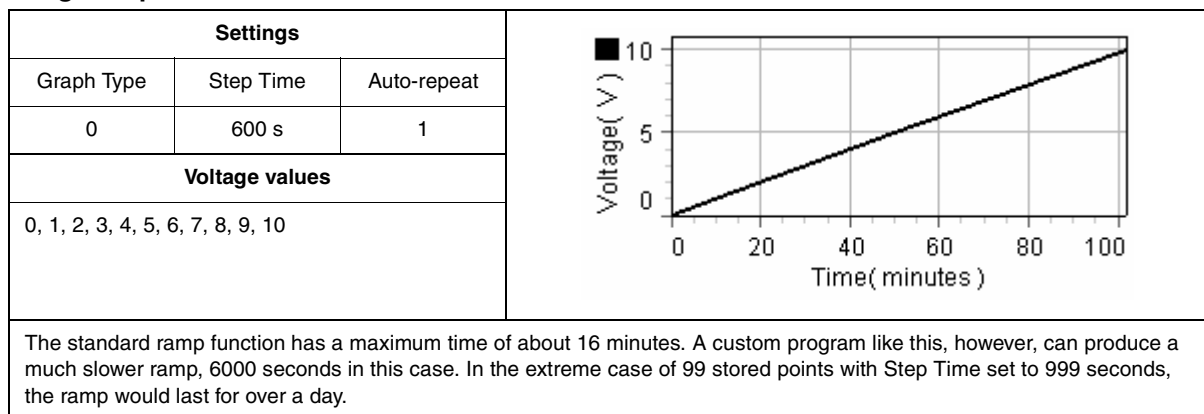

Variable Step Height

Settings		
Graph Type	Step Time	Auto-repeat
1	2 s	1
Voltage values		
0, 3, 5.5, 7.5, 9, 10		

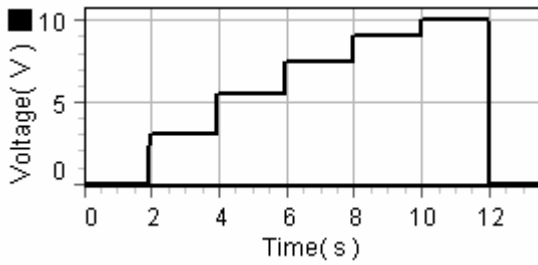

The standard step function requires each step to have the same height. This custom program allows a different height for each step.

Variable Step Width

Settings		
Graph Type	Step Time	Auto-repeat
1	0.5 s	1
Voltage values		
0, 0, 0, 0, 0, 0, 2, 2, 2, 2, 2, 4, 4, 4, 4, 4, 6, 6, 6, 8, 8, 8, 10, 10		

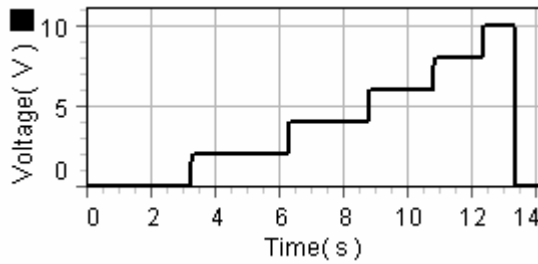

The standard step function requires each step to have the same width. This custom program allows each step to have a different width.

Variable Pulse Width

Settings		
Graph Type	Step Time	Auto-repeat
1	0.5 s	0
Voltage values		
5, 0, 0, 0, 0, 0, 0, 0, 0, 0, 5, 5, 5, 5, 5, 5, 0, 0, 0		

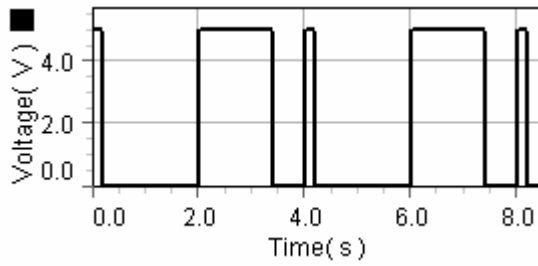

The standard square-wave function allows you to change the duty cycle, but all the pulses must have the same width. With this custom program you can create almost any pattern of pluses (including Morse code).

Variable Pulse Height

Settings		
Graph Type	Step Time	Auto-repeat
1	-0.5 s	0
Voltage values		
10, 0, 0, 0, 8, 0, 0, 0, 6, 0, 0, 0, 4, 0, 0, 0, 2, 0, 0		

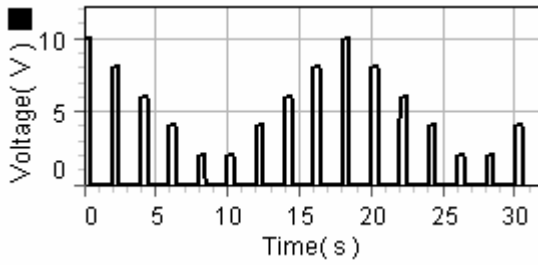

This program simulates Pulse Amplitude Modulation (PAM), which is used to introduce the modulation scheme known as Pulse Code Modulation.

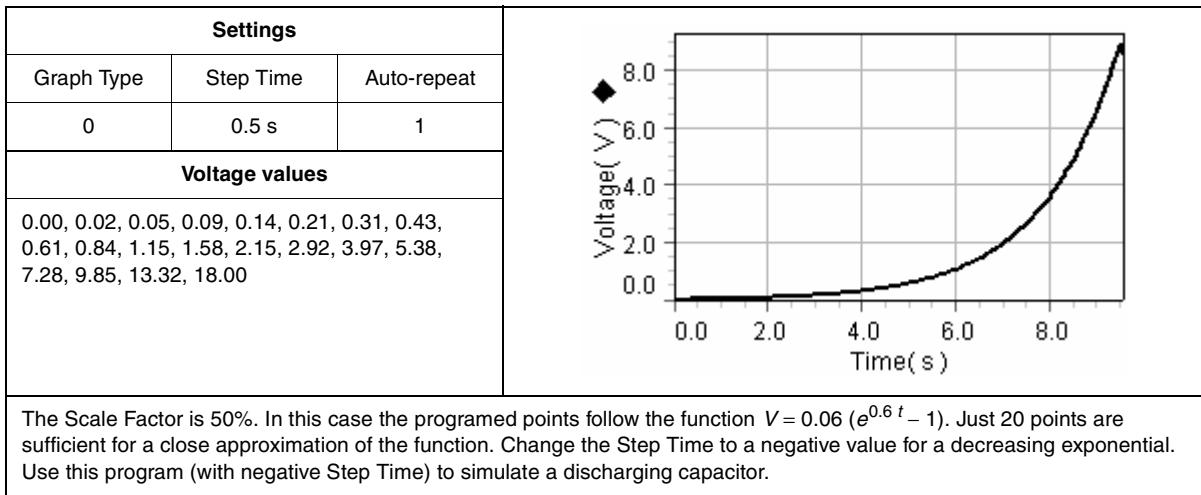
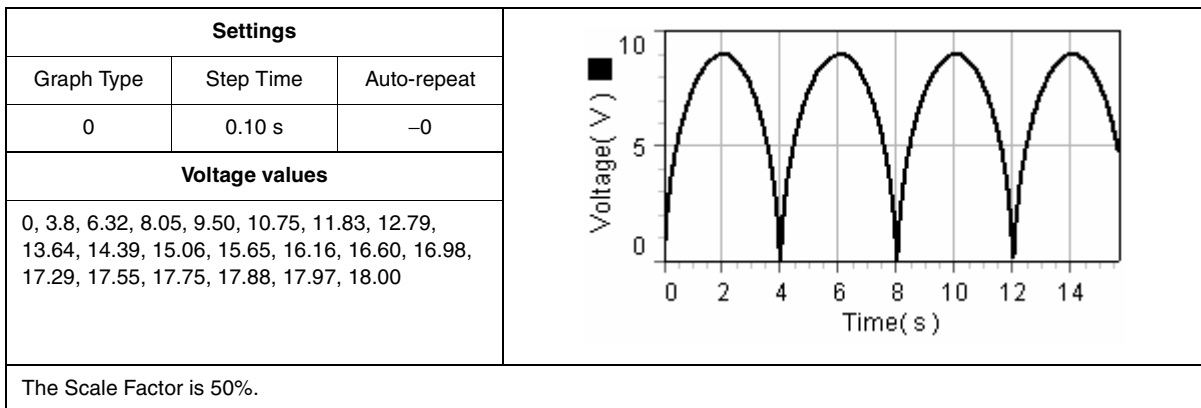
Exponential**Cycloid**

Technical Support

For assistance with any PASCO product, contact PASCO at:

Address: PASCO scientific
10101 Foothills Blvd.
Roseville, CA 95747-7100

Phone: 916-786-3800 (worldwide)
800-772-8700 (U.S)

Fax: (916) 786-3292

Web: www.pasco.com

Email: support@pasco.com

Before you call for Technical Support for assistance with the DC Programmable Power Supply, please check your Power Supply's firmware version number. To do so, turn on the unit; the display will briefly flash **8.8.8.8.**, then flash the version number (for instance, **1.0**).

For more information about the DC Programmable Power Supply and the latest revision of this Instruction Manual, visit the PASCO web site and enter PI-9880 into the Search window.

Limited Warranty

For a description of the product warranty, see the PASCO catalog.

Copyright

The PASCO scientific 012-12695A *DC Programmable Power Supply Instruction Manual* is copyrighted with all rights reserved. Permission is granted to non-profit educational institutions for reproduction of any part of this manual, providing the reproductions are used only in their laboratories and classrooms, and are not sold for profit. Reproduction under any other circumstances, without the written consent of PASCO scientific, is prohibited.

Trademarks

PASCO, PASCO scientific, and DataStudio are trademarks or registered trademarks of PASCO scientific, in the United States and/or in other countries. All other brands, products, or service names are or may be trademarks or service marks of, and are used to identify, products or services of, their respective owners. For more information visit www.pasco.com/legal.

