

PASPORT Soil Moisture Sensor

PS-2163

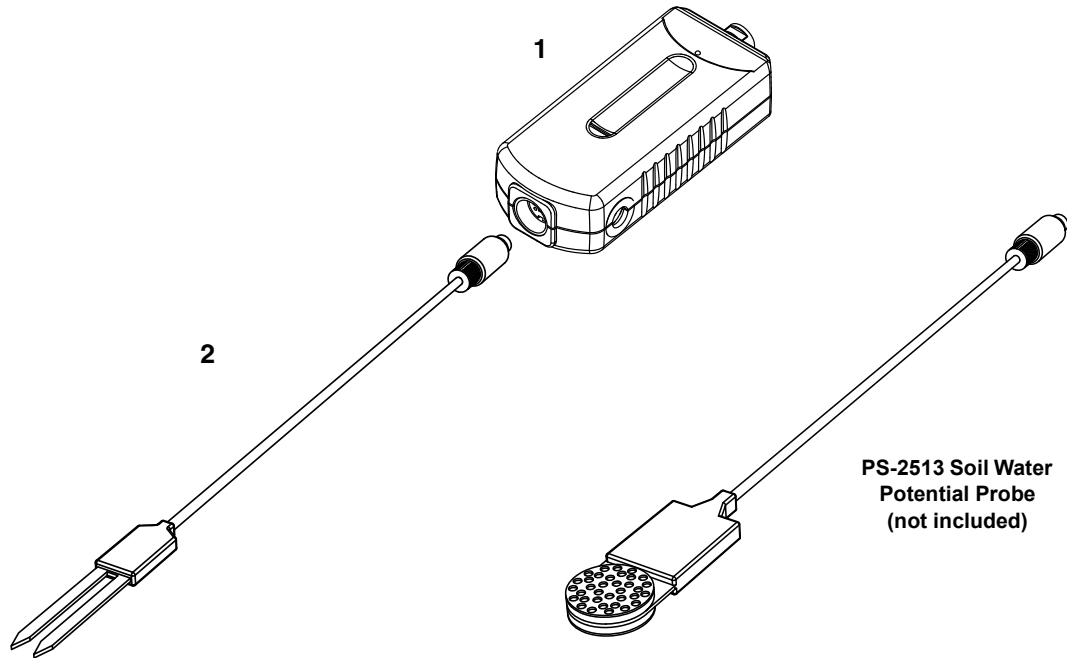

Included Equipment

1. PASPORT Soil Moisture Sensor
2. Soil Moisture Probe Cable Assembly

Part Number

PS-2163
514-10696

Accessory Equipment

(See the PASCO Catalog for details)

PASPORT Soil Water Potential Probe (not included)

PS-2513*

Compatible PASPORT Interfaces

(See the PASCO Catalog for details)

Xplorer

PS-2000

PowerLink

PS-2001

Xplorer GLX

PS-2002

SPARK Science Learning System

PS-2008

SPARKlink

PS-2009

USB Link

PS-2100

*See the PASCO catalog or visit the PASCO web site at www.pasco.com for more information about the PS-2513 Soil Water Potential Probe.

Introduction

The PASCO Model PS-2163 Soil Moisture Sensor works with a PASCO interface to collect soil moisture data. The sensor consists of the Soil Moisture Sensor box and the the Soil Moisture Probe (cable assembly).

The sensor measures volumetric water content (VWC) percentage of a soil sample. Volumetric water content is the volume of soil water per unit of total volume. In simple terms, dry soil consists of solid material and air pockets. A typical volumetric ratio would be 55% solid material and 45% air pockets. As water enters the soil, the air pockets begin to fill with water. An example of 10% volumetric water content would be 55% solid material, 35% air pockets, and 10% water. The maximum volumetric water content would therefore be 45%. All the air spaces would be filled with water and the soil would be saturated.

About the Sensor

The Soil Moisture Probe uses capacitance to measure the dielectric permittivity of the surrounding soil. The volume of water in the total volume of soil most heavily influences the dielectric permittivity because the dielectric of water (80) is much greater than the other constituents of the soil (mineral soil, 4; organic matter, 4; air, 1). Thus, when the amount of water changes in the soil, the Soil Moisture Probe will measure a change in the capacitance (from the change in the dielectric permittivity) that can be directly correlated with a change in water content. Circuitry inside the Soil Moisture Probe changes the capacitance measurement into a proportional millivolt output.

The Soil Moisture Probe averages the volumetric water content over the entire length of the probe, with a zone of influence about 2 cm around the probe. The zone of influence is with respect to the flat surface; there is little or no sensitivity at the edges of the probe. The electromagnetic field (EM) produced by the probe decreases with distance from the probe surface.

The copper traces used to measure water content are sealed between two pieces of epoxy-impregnated fiberglass. The electromagnetic (EM) field generated by the traces travels through the fiberglass and into the soil surrounding the probe.

Installing the Soil Moisture Probe

When selecting a site for installation of the probe, it is important to remember that the soil adjacent to the probe's surface has the strongest influence on the sensor reading. Therefore, any air gaps or excessive soil compaction around the probe can profoundly affect the readings. Because the probe has a gap between its prongs, it is also important to consider the size of the media you are inserting the probe into. It is possible to get sticks, bark, roots, or other material stuck between the probe prongs, which will adversely affect readings. Finally, be careful when inserting the probe into dense soil, as the prongs will break if excessive sideways force is used when pushing them in.

When installing the probe, it is best to maximize contact between the probe and the soil.

Vertical Orientation

Insert the probe into the soil, making sure that the probe is completely buried at least 3 cm below the soil surface. The tip of each prong is sharp - *be careful!*

The probe may be difficult to insert into extremely compact or dry soil. Carefully loosen the soil before inserting the probe. **Never pound the probe into the soil!**

Make sure that there is good contact between the probe and the soil. Use your fingers and fist to tamp the soil down around the probe.

Do not install the probe adjacent to large metal objects such as metal poles or stakes. This can attenuate the probe's electromagnetic field and adversely affect output readings.

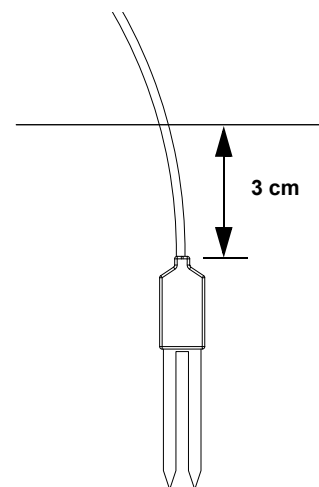

Horizontal Orientation

The probe can be oriented in any direction. However, orienting the flat side perpendicular to the surface of the soil will minimize the effects of downward water movement. The horizontal orientation of the probe makes sure that the soil moisture measurement is made at a particular soil depth.

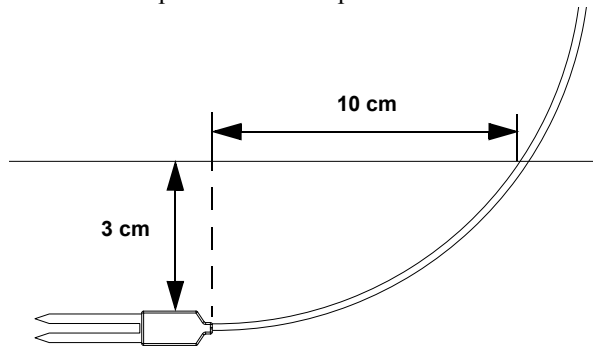

Do not bend the cable too severely when putting the probe into the soil. Let about 10 cm of the cable nearest to the probe remain straight or gently curved as shown.

Make a narrow trench with a trenching shovel or garden spade. Place the probe into the narrow trench and completely cover the entire length with soil. Tamp down the soil along both sides of the probe with your fingers. Cover with more soil if needed. Repeat the process of tamping down the soil along both sides of the probe five to eight times.

Removing the Soil Moisture Probe

When removing the soil moisture probe from the soil, **do not pull it out of the soil by the cable!** Doing so may break internal components and make the probe unusable.

Setup

Hardware Setup

The following three steps can be performed in any order.

1. Connect the mini-DIN plug of the Soil Moisture Probe Cable Assembly to the front end of the Soil Moisture Sensor box.
2. Connect the Soil Moisture Sensor to a PASPORT interface.
3. If you will be using a computer, connect the PASPORT interface to the computer's USB port.

The mini-DIN plug on the Soil Moisture Cable Assembly fits into the sensor box in only one way.

DataStudio Setup

If you will be using the Soil Moisture Sensor with a computer, install the latest version of DataStudio first. Check the PASCO web site at www.pasco.com for information.

1. When you connect the Soil Moisture Sensor to the computer through a PASPORT interface, the PASPortal window will launch automatically (if DataStudio is not already running).
2. Select *Launch DataStudio* in the PASPortal window.

A Digits display for volumetric moisture content (% VWC) will appear. The default is for Potting Soil.

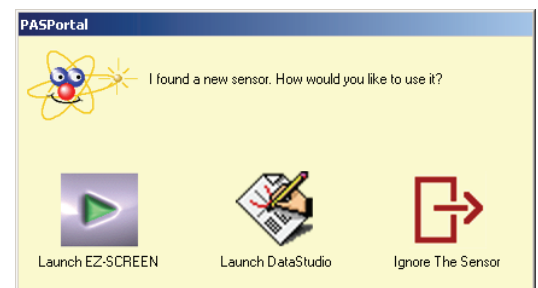

- Click  to begin data collection.

To view and change the sample rate, click . Note that the best results are usually obtained with the sample rate left at the default setting of 10 Hz (10 measurements per second).

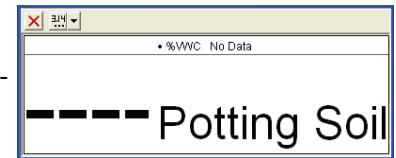

Xplorer Setup

Turn on the Xplorer and connect the Soil Moisture Sensor. The display will show “%VWC Potting S”. Press  to begin data collection.

Xplorer GLX Setup

If you will be using an Xplorer GLX in logging mode (not connected to a computer), turn on the Xplorer GLX and connect the Soil Moisture Sensor. A digits display of Volumetric Water Content (%VWC (Potting Soil)) and Sensor Voltage Output (SensorVout (mV)) will appear. Press  to begin data collection.

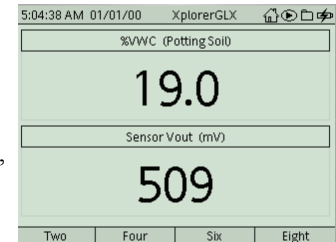

SPARK Setup

- If the SPARK Science Learning System (SLS) is off, press and hold the power button on the bottom to turn it on and then wait for the SPARK to boot up. The screen will show a message to plug in a sensor.
- Connect the PASPORT sensor to either of the ports on the top of the SPARK. The screen will show the list of quantities measured by the connected sensor.

spark 
TO BEGIN
COLLECTING DATA
PLUG IN A SENSOR

Graph Display (default)

To open a graph display, touch any quantity in the list and then touch SHOW to open PAGE 1. Touch the right arrow next to PAGE 1 to go to the next display (digits). Touch the **Start** button to begin collecting data.



Select a Display

To set up a particular display (e.g., digits display), touch BUILD^①. Touch a quantity from the list^②, and then touch one of the display icons^③. Touch OK^④ to open the display, and then touch the **Start** button to begin collecting data.

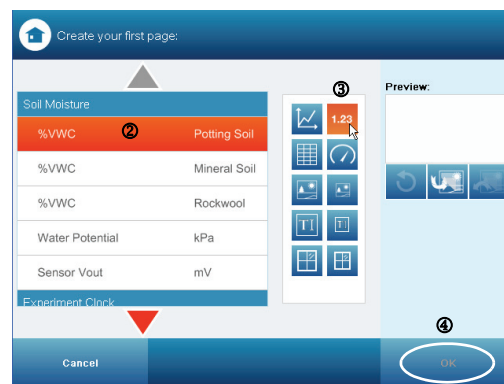
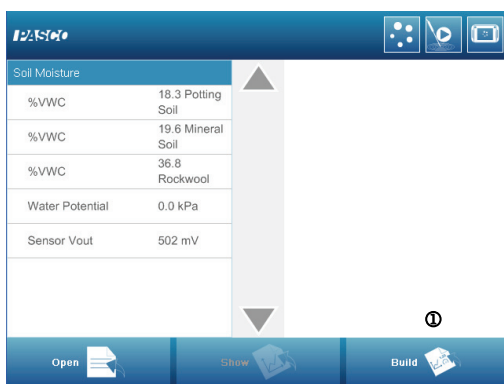

Calibration



The Soil Moisture Sensor comes pre-calibrated for three soil types: potting soil, mineral soil, and rockwool. The Soil Moisture Probe is insensitive to variation in texture



Rockwool is a green fibrous mat visually similar to fiberglass insulation used to grow greenhouse crops in hydroponics.

and soil conductivity because it operates at a high frequency. Therefore, its calibrations should apply for all potting soil, mineral soil, and rockwool.

Selecting Soil Type

In DataStudio, click Setup ( Setup) to open the Experiment Setup window. In the Experiment Setup window, click the menu button under “Unit of Measure” and select the soil type.

With the Xplorer, press the check button () to highlight the soil type, then press the plus button () to toggle through the soil selection choices. Press the check button again to select your choice.

With the Xplorer GLX showing %VWC in the digits display, press the check button () to open the selection menu for the display. Use the right cursor arrow key () to open the soil type menu, and then use the down cursor arrow key () to select the soil type. Press the check button again to select your choice.

With the SPARK SLS, connect the Soil Moisture Sensor and select the soil type from the list of choices that will appear on the screen.

Other

If the type of soil or media that you are using does not appear in the Unit of Measure list, you may want to make measurements to create a soil specific calibration curve yourself, or take advantage of Decagon’s calibration service.

Information on individual probe calibration can be found online at www.decagon.com/appnotes/echocal.pdf

Information on Decagon’s calibration service can be found at www.decagon.com/echo/calibration.html.

Creating a Calibration Curve

Volumetric Water Content (VWC) is the ratio of the volume of water per volume of bulk soil. One way to create a soil specific calibration curve is to match the voltage output from the Soil Moisture Probe to VWC values for several soil samples with different degrees of dryness, and then plot a graph of VWC versus probe output in millivolts (mV).

The basic process is to collect a measured volume of bulk soil, measure its mass, measure the probe reading in mV for the bulk soil, dry the soil to determine the amount of water that was in the soil, and calculate the ratio of the volume of water to the volume of bulk soil. Then, create a graph of VWC versus probe voltage and determine the “best fit” for the graph. If the graph is linear, determine the slope and y-intercept. If the graph is quadratic, determine the coefficients of each term. A *linear* calibration curve would have a formula of $y = mx + b$ where y is the VWC, m is the slope, x is the probe output in mV, and b is the y-intercept. Finally, create a calculation based on the formula for the soil specific calibration curve.

Equipment: shovel and bulk soil container, calibration container, Soil Moisture Probe and PASCO Interface, volumetric soil sampler¹, soil drying containers with lids (e.g., baby food jars), scale or mass balance, drying oven.

Procedure:

1. Collect approximately 4 liters of bulk soil from the depth/location where you want to measure with the probe.

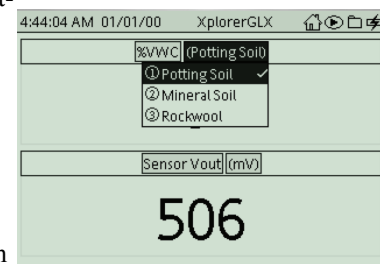
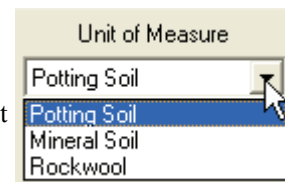

The Soil Moisture Probe is built by Decagon Devices, Inc.
2365 NE Hopkins Ct.
Pullman, WA 99163

See the User’s Guides for the Xplorer GLX or the SPARK Science Learning System for calibration instructions.

A *quadratic* calibration curve would have a formula of $y = ax^2 + bx + c$ where y is the VWC, x is the probe output in mV, and a , b , and c are coefficients.

¹ A volumetric soil sampler could be a 3 to 5 cm section of metal conduit or other small diameter (1.5 to 2.5 cm) metal or thin walled plastic tubing. Deburr both ends and sharpen one end for easy insertion into the soil. Measure its dimensions and calculate the volume, $V = \pi r^2 h$

2. Air dry the soil (spread the soil in a thin layer and use a fan to move air over the soil.)
3. Remove large objects from the soil and break up large clods so the soil can fit through a 5 mm mesh.
4. Pack the soil into the calibration container at approximately the field bulk density.
5. Insert the Soil Moisture Probe fully into the soil. Connect the probe to the sensor and the sensor to the interface and use the sensor to make a measurement in millivolts (mV). Record the measurement.
6. Use the volumetric soil sampler to collect a sample near the probe. Place the soil sample into a drying container. Measure and record the mass of the soil sample plus the drying container and then replace the lid on the drying container*.
7. Wet the calibration soil by adding 200 to 300 milliliters of water to the soil as evenly as possible. Thoroughly mix the soil.
8. Repeat steps 3 through 7 until the soil approaches saturation. This generally yields five to seven calibration points.
9. Remove the lids from the drying containers. Dry the volumetric soil samples in a 105 C oven for 24 hours.
10. Remove the soil drying containers from the oven and replace the lids. Allow the containers to cool.
11. Measure and record the mass of the dry soil plus the container (without lid).

*Any water loss due to evaporation after sampling introduces error to the volumetric water content calculation.

Calculations:

1. Determine and record the volume of water by subtracting the dry soil mass from the “wet” (pre-dried) soil mass. Convert the mass difference into a volume based on the density of water (1 g/cm³).
2. Calculate and record the volumetric water content by dividing the volume of water (cm³) by the volume of the soil sample (cm³).

Analysis:

1. Plot volumetric water content versus the sensor voltage output (in mV). Open a data table and enter the values for sensor voltage output (x-axis) and volumetric water content (y-axis).
2. Open a graph display and use the “Fit” function to find the “best fit” for the plotted data. (Try “Linear” first and then “Quadratic”). Record the slope and the y-intercept. (If the best fit is quadratic, record the coefficient, a, b, and c.)
3. Create a calculation for VWC based on the slope and the y-intercept ($VWC = mx + b$). Let “x” be the sensor voltage output.

If the best fit is quadratic, create a calculation for VWC based on the coefficients, a, b, and c.

$$VWC = ax^2 + bx + c$$

where x is the sensor voltage output.

Sample Calibration Data

	Sensor voltage output (mV)	Sample volume (cm ³)	Mass of container + moist soil (g)	Mass of container + dry soil (g)	Volume of water (cm ³)	VWC (cm ³ /cm ³)
1	664	15.31	94.836	94.215	0.621	0.0406
2	764	15.31	96.433	95.194	1.239	0.0809
3	902	15.31	96.923	94.785	2.138	0.1396
4	1030	15.31	101.979	98.834	3.145	0.2054
5	1318	15.31	100.402	95.873	4.529	0.2958
6	1374	15.31	101.060	95.886	5.174	0.3379

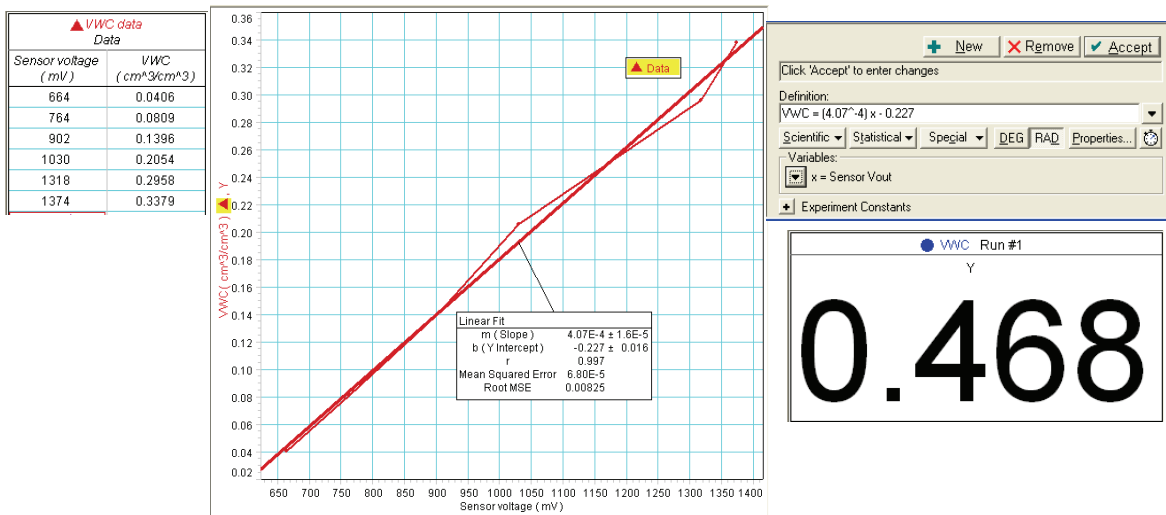

Experiment Suggestions

- Measure soil moisture over time.
- Evaluate soil moisture content for various species of plants to determine the optimal level of soil moisture.
- Examine soil moisture content in a greenhouse to determine the amount of irrigation.

Specifications (PS-2163)

Sensor Range	0 to 45% volumetric water content in soil
Accuracy	± 4%
Resolution	0.1%
Power	3 mA at 5 V DC
Operating Temperature	-40 to + 60 °C
Default Sample Rate	10 samples per second

PASCO Soil Water Potential Probe (PS-2513)

Introduction

There are two basic parameters that describe the state of water in soil: one is soil water content, or the amount of water per unit of soil, and the other is soil water potential, or the energy state of the water in the soil. Water potential is often preferred over water content because it shows how water will move in a soil or from the soil to the plant. In an object comes into hydraulic contact with soil, the water potential of the object will come into equilibrium with the soil water potential.

The Soil Water Potential Probe uses a solid matric equilibration technique to measure the water potential of the soil. The probe has a static matrix - a porous ceramic disk - that is allowed to reach hydraulic equilibrium with the soil that is being measured. The probe measures the dielectric permittivity of the ceramic disk to determine its water potential and thereby the water potential of the soil.

In the engineering community, "soil suction" is used instead of soil water potential. Soil water potential is simply the negative of soil suction.

Installing the Probe

Because it measures water potential, the probe needs good hydraulic contact with the surrounding soil. The preferred method for installing the probe is to take some native soil, wet it, and pack it in a ball around the entire probe, making sure that the moist soil is in contact with all surfaces of the ceramic disk. The probe and moist soil are then packed into the soil at the desired depth.

After the probe is installed, the hole that was excavated to bury the probe should be back-filled with care taken to re-pack the soil back to its native bulk density. Leave at least 15 cm of cable beneath the soil. Do not bend the cable in a tight radius as it leaves the probe. At least 10 cm of cable nearest the probe should remain in a straight line.

Removing the Probe

When removing the soil water potential probe from the soil, **do not pull it out of the soil by the cable!** Doing so may break internal components and make the probe unusable.

Handling and Care

For the probe to accurately measure water potential, the ceramic disks must readily take up water. If the ceramic disks are exposed to oils or other hydrophobic substances, then the ability of the disks to take up water can be compromised. As much as possible, minimize the exposure of the ceramic disks to skin oils, synthetic oils, or other hydrophobic compounds.

The probe consists of two engineered ceramic disks sandwiched between stainless steel screens and the probe's circuit board. The disks are brittle and can chip or crack if mishandled. Sharp trauma such as dropping the probe onto a hard surface can cause the ceramic to break. A cracked ceramic will cause a loss of accuracy.

Frozen Soil

Under frozen soil conditions, the probe cannot accurately measure the water potential of soil. However, the probe is unaffected by repeated freeze-thaw cycles, so the probe can remain in the soil year round.

Setup

Hardware Setup

The following three steps can be performed in any order.

1. Connect the mini-DIN plug of the Soil Water Potential Probe cable to the front end of the Soil Moisture Sensor box.
2. Connect the Soil Moisture Sensor to a PASPORT interface.
3. If you will be using a computer, connect the PASPORT interface to the computer's USB port.

The mini-DIN plug on the Soil Water Potential Probe cable fits into the sensor box in only one way.

DataStudio Setup

If you will be using the Soil Moisture Sensor with a computer, install the latest version of DataStudio first. Check the PASCO web site at www.pasco.com for information.

1. When you connect the Soil Moisture Sensor to the computer through a PASPORT interface, the PASPortal window will launch automatically (if DataStudio is not already running).
2. Select *Launch DataStudio* in the PASPortal window.

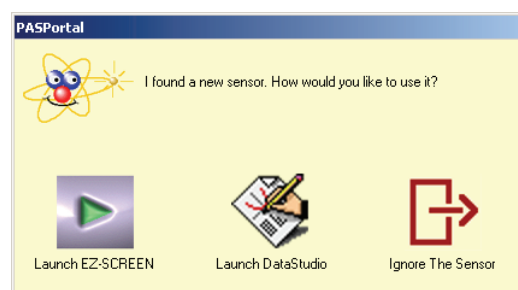

A Digits display for soil moisture (%VWC) and Water Potential (kPa) will appear.

3. In the Digits display, select %VWC (Potting Soil) to make it active, and then remove it using the delete (X) button in the toolbar.
4. Click  to begin data collection.

To view and change the sample rate, click . Note that the best results are usually obtained with the sample rate left at the default setting of 10 Hz (10 measurements per second).

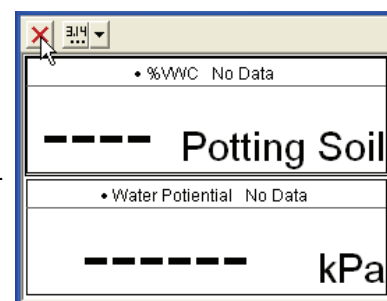

Xplorer and Xplorer GLX Setup

If you will be using an Xplorer or Xplorer GLX in logging mode (not connected to a computer), connect the sensor to the Xplorer or Xplorer GLX, and then press  to begin data collection.

SPARK Setup

- If the SPARK Science Learning System is off, press and hold the power button on the bottom to turn it on and then wait for it to boot up.
- Connect the sensor. Touch “Water Potential” in the list that appears, and then touch SHOW to open a default graph display, or touch BUILD to select a particular display (e.g., digits display), and then touch “Water Potential” and the desired display icon, and finally touch OK.

Touch the **Start** button to begin data collection. .



Specifications (PS-2513)

Sensor Range	-10 to -50 kPa (pF 2 to pF 3.71)
Accuracy	± 5% from -10 to -50 kPa ± 20% of reading from -50 to -500 kPa
Resolution	1 kPa from -10 to -100 kPa 4 kPa from -100 to -500 kPa
Power	25 mA at 2 to 5 V DC
Operating Temperature	0 to + 50 °C
Default Sample Rate	10 samples per second

Calibration

The Soil Water Potential Probe does not require any calibration by the user.

The probe's survival temperature is from -40 to +50 °C.

Technical Support

For assistance with any PASCO product, contact PASCO at:

Address: PASCO scientific
10101 Foothills Blvd.
Roseville, CA 95747-7100

Phone: 916-786-3800 (worldwide)
800-772-8700 (U.S.)

Fax: (916) 786-3292

Web: www.pasco.com

Email: support@pasco.com

For more information about the Soil Moisture Sensor and the latest revision of this Instruction Manual, visit:

www.pasco.com/go?PS-2163

Limited Warranty For a description of the product warranty, see the PASCO catalog. **Copyright** The PASCO scientific 012-10538A *Soil Moisture Sensor Instruction Manual* is copyrighted with all rights reserved. Permission is granted to non-profit educational institutions for reproduction of any part of this manual, providing the reproductions are used only in their laboratories and classrooms, and are not sold for profit. Reproduction under any other circumstances, without the written consent of PASCO scientific, is prohibited. **Trademarks** PASCO, PASCO scientific, DataStudio, PASPORT, Xplorer, and Xplorer GLX are trademarks or registered trademarks of PASCO scientific, in the United States and/or in other countries. For more information visit www.pasco.com/legal. Windows is a registered trademark of Microsoft Corporation in the United States and/or other countries. Mac is a trademark of Apple Computer, Inc., registered in the U.S. and other countries.

Product End of Life Disposal Instructions:

This electronic product is subject to disposal and recycling regulations that vary by country and region. It is your responsibility to recycle your electronic equipment per your local environmental laws and regulations to ensure that it will be recycled in a manner that protects human health and the environment. To find out where you can drop off your waste equipment for recycling, please contact your local waste recycle/disposal service, or the place where you purchased the product.

The European Union WEEE (Waste Electronic and Electrical Equipment) symbol (to the right) and on the product or its packaging indicates that this product **must not** be disposed of in a standard waste container.

