

Bridge Set

ME-6991

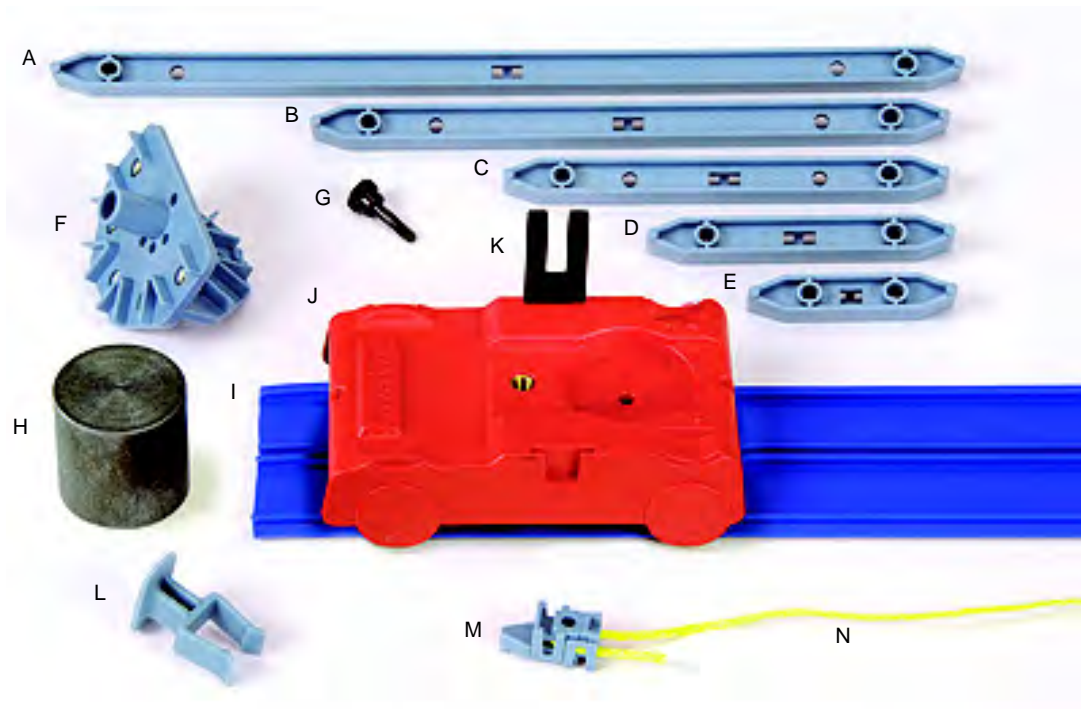

Table of Contents

Included Equipment	3
Related Equipment	4
Introduction	4
About the Components	4
Adding Load Cells	5
Properties of I-Beams	7
Simple Triangles	7
Trusses	7
Common Truss Bridges	8
Different Scales	9
Bridge Deflection Under Load	10
Bridge Challenges for Students	11
Measuring Static and Dynamic Loading	11
Bridges That Require Two or More Bridge Sets	12
Dynamics Track	13
Rollercoaster Design Challenges	13
Technical Support	14

Bridge Set

ME-6991



Included Equipment	Qty	Included Equipment	Qty
A. #5 Beams (24 cm long)	16	H. Mini-car Mass (about 200 g)	1
B. #4 Beams (17 cm long)	16	I. Road Bed (3 m)	1
C. #3 Beams (11.5 cm long)	36	J. Mini-car	1
D. #2 Beams (8 cm long)	36	K. Photogate Flag	1
E. #1 Beams (5.5 cm long)	16	L. Road Bed Clips	24
F. Brackets	28	M. Cord Clamps	32
G. Screws (6-32)	150	N. Yellow Cord	76 m

Related Equipment

Load Cell and Amplifier Set (PS-2199)
 Load Cell Amplifier (PS-2198)
 100 N Load Cell (PS-2200)
 Truss Set (ME-6990)

Related Equipment

Road Bed Spares (ME-6995)
 PASPORT Interfaces
 DataStudio Software

Introduction

The Bridge Set is one part of the PASCO Structures System. Although the Bridge Set can be used as a stand-alone set, it can also be combined with other parts of the PASCO Structures System. The Load Cell and Amplifier Set (PS-2199) can be added to measure compression and tension forces in the structure members and other sets of plastic parts are available.

The PASCO Structures System includes:

Truss Set (ME-6990) - A small set for building trusses

Bridge Set (ME-6991) - A larger set with road bed and cables for building bridges and rollercoasters

Advanced Set (ME-6992) - The largest set with pulleys, axles, and additional connectors that make possible bridges which have angles other than 45 and 90 degrees. This set can also be used to build suspension bridges, cranes, cars and catapults.

Load Cell and Amplifier Set (PS-2199) - Load Cell Amplifier (PS-2198) with four 100 N Load Cells (PS-2200)

Load Cell Amplifier (PS-2198) - Can plug in up to six Load Cells; requires a PASPORT interface to connect to the USB port of a computer.

100 N Load Cell (PS-2200) - Strain gauges mounted on a beam; no electronics so a Load Cell requires the Load Cell Amplifier (PS-2198).

The Bridge Set includes beams, brackets, screws, cord tensioning clamps, a Mini-car, and a flexible road bed for building various trusses and bridges. Dynamics tracks can also be constructed to study motion. In addition, rollercoaster design can be studied.

About the Components

Assembling Beams

Attach beams to brackets as illustrated.

Each bracket has eight slots, labeled A through H, for accepting beams. There are five sizes of beams, labeled #1 through #5. Beam #1 is the shortest beam.

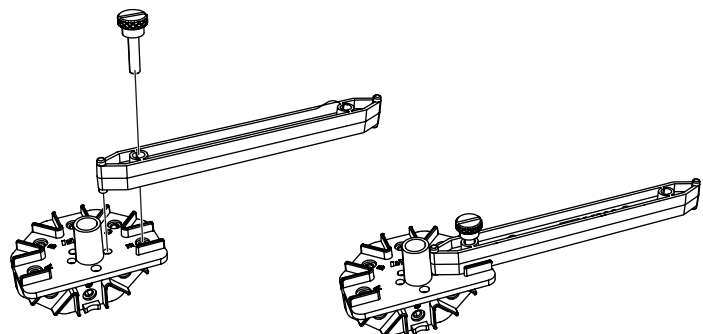

Figure 1: Attaching a beam to a bracket

Attaching Cords

When attaching cords for lateral bracing or for suspension or cable-stayed bridges, Cord Clamps are used to assist in adjusting the tension in the cords.

The Cord Clamp does not come apart. It is best to thread the cord through the clamp before the clamp is installed on the bridge. Prepare to thread the cord by holding the top half of the clamp as shown in Figure 3 so the two halves of the clamp will separate, leaving an opening through which the cord is threaded. The cord is inserted into the end opposite the pointed end of the clamp. The cord should be looped back through the clamp as shown in Figure 4. Then the Cord Clamp can be used in the bridge, using the attachment screw to tighten the clamp shut. To adjust the cord tension, loosen the screw and pull on the cord to the desired tension and then tighten the screw.



Figure 2: Lateral bracing

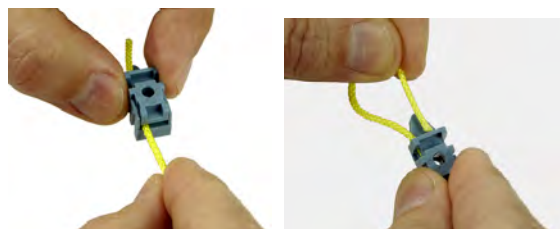

Figure 3: Hold half of the cord lock so the two halves separate

Figure 4: Loop the cord back through the cord lock

Attaching the Road Bed

To attach the blue road bed to the cross-members of a bridge, first connect the road bed clips to the underside of the road bed by twisting the clip into the slot so the edges of the slot capture the clip (see Figure 7).

Slide the clip in the slot a short distance to align it with the cross member of the bridge.

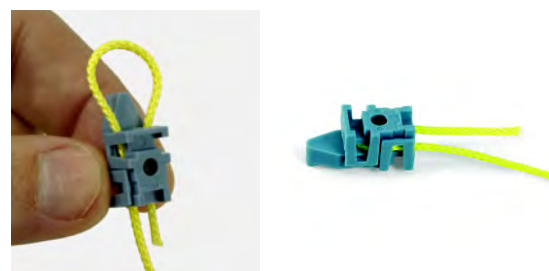

Figure 5: The cord goes around the screw hole

Figure 6: The cord lock is ready to be attached to the structure using a screw

Using the Mini-car

The ridges in the road bed guide the Mini-car wheels. The supplied mass (approximately 200 g) can be set in the recess in the Mini-car to give the car more mass. If smaller masses are desired, use the Mass and Hanger Set (PASCO Model ME-8979).

The photogate flag fits into the slot on the side of the Mini-car. As the car passes through a photogate, the infrared beam is blocked twice by the flag. To find the speed of the car, measure the distance between the leading edges of the flag (approximately 1 cm) and measure the time between the events when the infrared beam is blocked.



Figure 7: Attach road bed clip to road bed

The Accessory Photogate with Stand (PASCO Model ME-9204B) is useful as a free-standing photogate.

Adding Load Cells

To measure the compression and tension forces in individual members, add load cells (PASCO Model PS-2199) to any PASCO Structure. Replace a beam with two shorter beams and a load cell.

#5 beam = load cell + two #3 beams

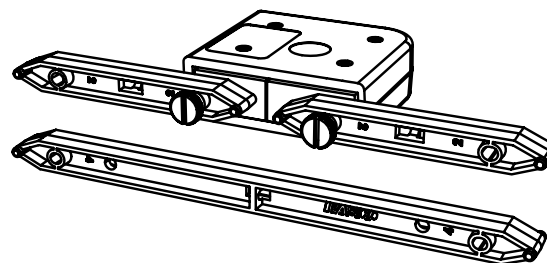

Figure 8: A load cell combined with two #2 beams is the same length as a #4 beam

#4 beam = load cell + two #2 beams

#3 beam = load cell + two #1 beams

Use thumbscrews to attach two beams to a load cell as shown in Figure 8.

When using load cells, assemble your structure with the screws loose. This will simplify the analysis by ensuring that the members experience only tension and compression without moments.

See the instructions that came with the load cells for details about how to connect the load cells to an interface or datalogger and collect data.

Example: Bridge with Load Cells

The bridge shown in Figure 9 incorporates six load cells to measure the tension or compression in various members. A hanging mass is used to apply load. The mass is adjusted so that the compression in one of the legs is 1.0 N. Compression is registered as a positive value and tension as a negative value.

If the screws are loose, the theoretical analysis of the bridge can be carried out by assuming that the net force at each node is zero. Thus, the vertical component of compression in the left-most diagonal member must be 1 N (to oppose the force applied by the leg). The horizontal component must also be 1 N since the member is at a 45° angle. The predicted resultant force is:

$$\sqrt{(1.0 \text{ N})^2 + (1.0 \text{ N})^2} = 1.4 \text{ N}$$

The actual measured force confirms the theory.

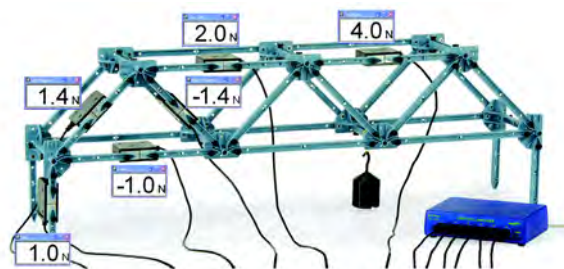

Figure 9: Bridge with load cells

Calibration of Load Cells

Load cells are factory calibrated; however, you can recalibrate them in software or on the datalogger. See the documentation for your software or datalogger for instructions.

When calibrating a load cell, it is necessary to apply a known load. Assemble the fixture shown in Figure 10 to support the load cell. Hold or clamp the fixture at the edge of a table and hang a mass from it as shown.

Note that the hanging mass applies tension to the load cell; therefore the known force that you enter into the software or datalogger should be a negative value. For example, if the mass is 1.0 kg, the applied force is -9.8 N.

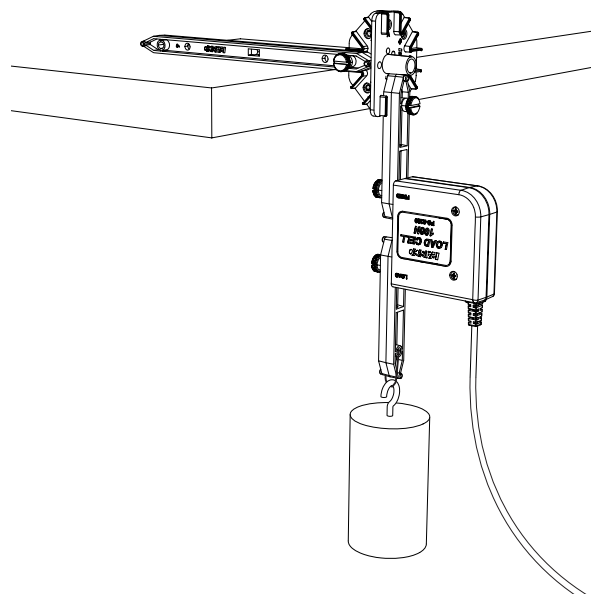

Figure 10: Calibration fixture

Properties of I-beams

This demonstration shows the difference between the X and Y bending moments of an I-beam.

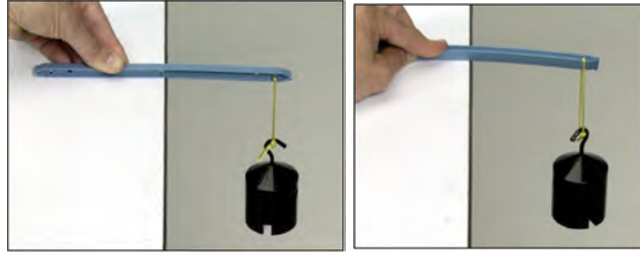

Figure 11: Bending an I-Beam

Simple Triangles

Most structures are made of isosceles right triangles as shown in Figure 12.

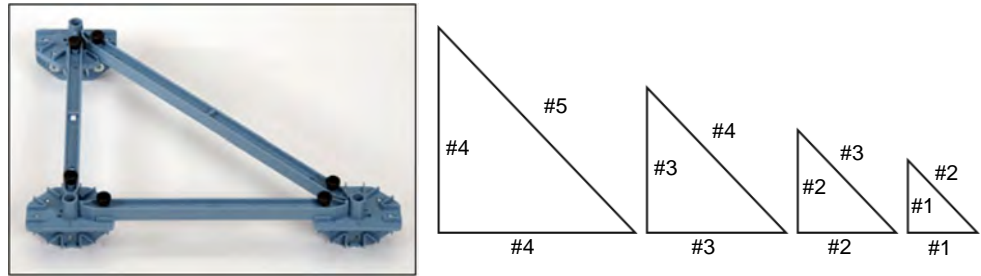

Figure 12: (Left) A triangle made from a #5 beam and two #4 beams. (Right) Combinations of beams to make triangles.

Trusses

Kingpost Truss

Figure 13 shows a simple kingpost truss made from #5 and #4 beams. Use a hanging mass to apply a load.

Lay the kingpost truss on the table to compare its horizontal and vertical stiffness.

To build a three-dimensional structure, connect two trusses with #4 beams (Figure 14).

Add cross bracing to increase stiffness.

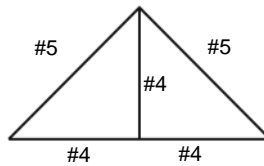

Figure 13: A simple kingpost truss

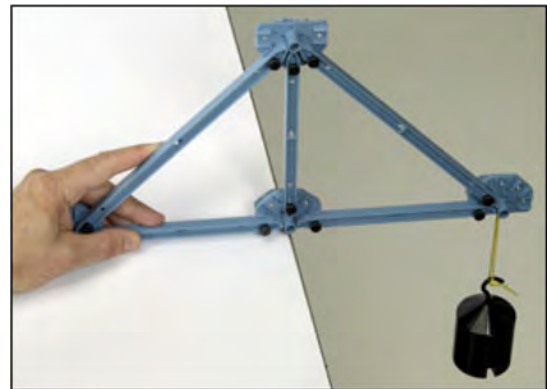
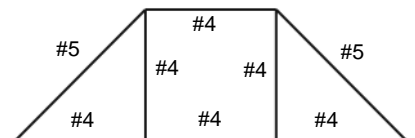

Figure 14: (Left) A three-dimensional kingpost truss structure. (Right) Kingpost truss with cross bracing

Queenpost Truss

To make a queenpost truss, separate the kingpost truss in the middle and add a square section..



Legs can be added to any truss or bridge (Figure 15).

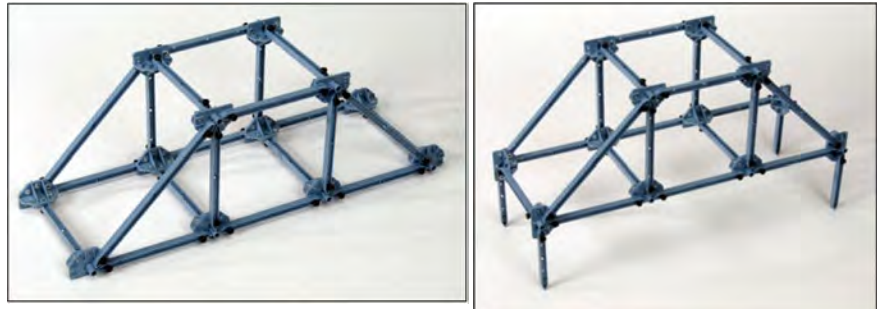

Figure 15: (Left) Queenpost truss. (Right) Queenpost truss with legs.

Roof Truss

Use #4 and #5 beams to build a simple roof truss or a roof truss structure with legs.

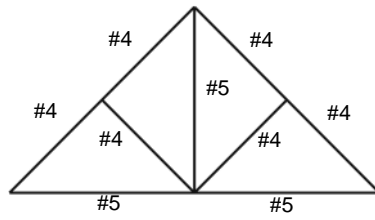
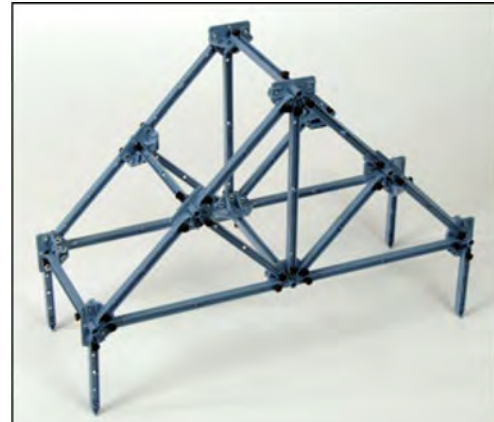

Figure 16: Roof truss



Common Truss Bridges

Warren Bridge

The Warren Bridge (Figure 17) is a simple type of bridge consisting of a series of triangles. However, a simple Warren Bridge is not practical for supporting a deck (road bed). Vertical members can be added to support the deck. Additional verticals can support an upper deck.

To make a free-standing bridge, begin by laying out one side of the bridge on a table. Then build the other side of the bridge. Join the two sides of the bridge attaching the floor beams and the top cross beams. Use additional members as piers to support the bridge. (Figure 18).

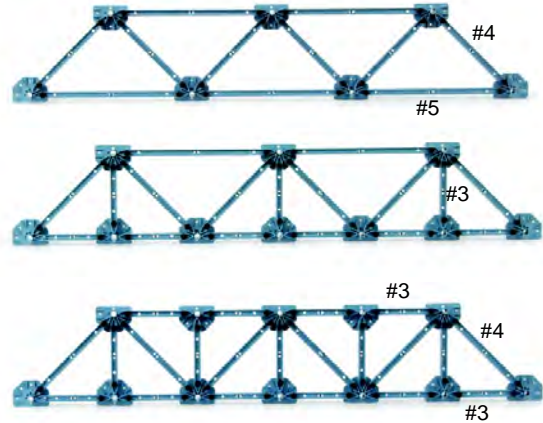

Figure 17: (Top) Warren Bridge. (Middle) Warren with deck verticals. (Bottom) Warren with verticals.



Figure 18: (Left) Free-standing Warren. (Right) Free-standing Warren with deck verticals

Different Scales

It is possible to build bridges of two different scales. In Figure 19 is a Warren with Verticals built to two different scales.

In spanning a particular distance, why wouldn't you use the smaller scale bridge and add more panels? An examination of the forces in the members of each size bridge will give the answer. If the smaller and larger bridges have the same number of panels and experience the same load, the forces in any member of the smaller bridge is the same as the same member in the larger bridge. Each additional panel is submitted to larger forces. This can be explored using load cells. See the section on Measurement of Static and Dynamic Loads

Figures 20 through 23 show additional common types of bridges. Investigate how the forces in these bridges differ from the Warren..

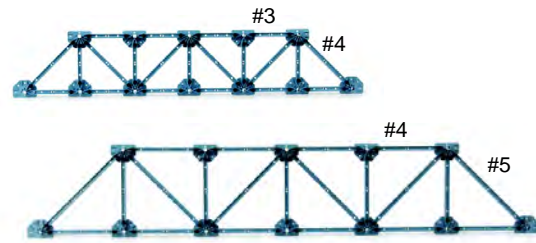

Figure 19: Smaller and Larger Scale Warren with Verticals

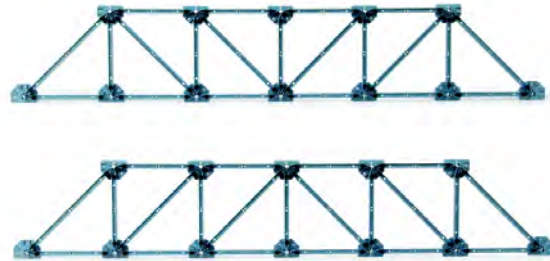

Figure 20: (Top) Pratt. (Bottom) Howe

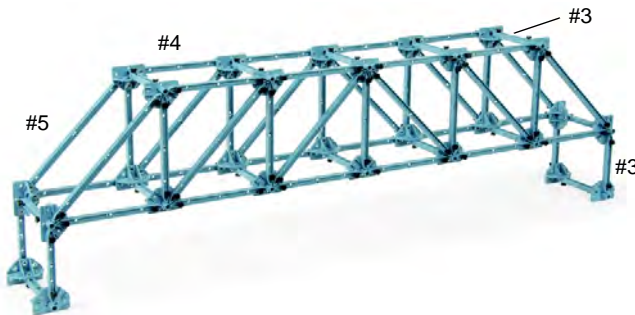

Figure 21: Free-standing Howe

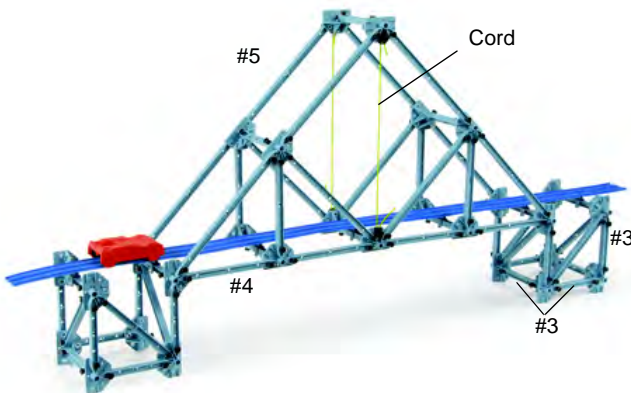

Figure 22: Waddell "A" Truss Bridge

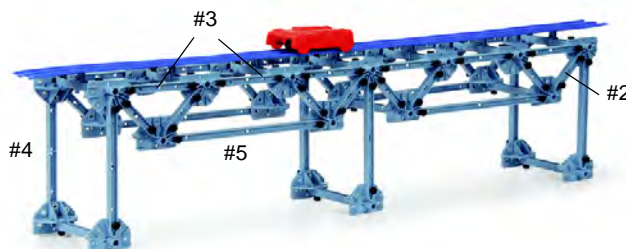

Figure 23: Deck Truss Bridge
(Connect the sides with #3 or #4 beams.)

Measuring Bridge Deflection Under Load

Because the members are made of plastic, it is easy to show bending in a bridge using relatively small loads.

NOTE: Do not attempt to load the bridge to the point of breaking.

Using a Motion Sensor

In Figure 24, the bridge is loaded by hanging a weight (Large Slotted Mass Set, PASCO Model ME-7566) from the center of the bridge. A Motion Sensor (PS-2103) is placed on the floor and pointed up toward the bottom of the weight hanger. A PASPORT interface (in this case, the Xplorer GLX, PS-2002) is used to record the amount of mass and the distance to the bottom of the weight hanger. A graph of the deflection as a function of the load is shown next to Figure 24.

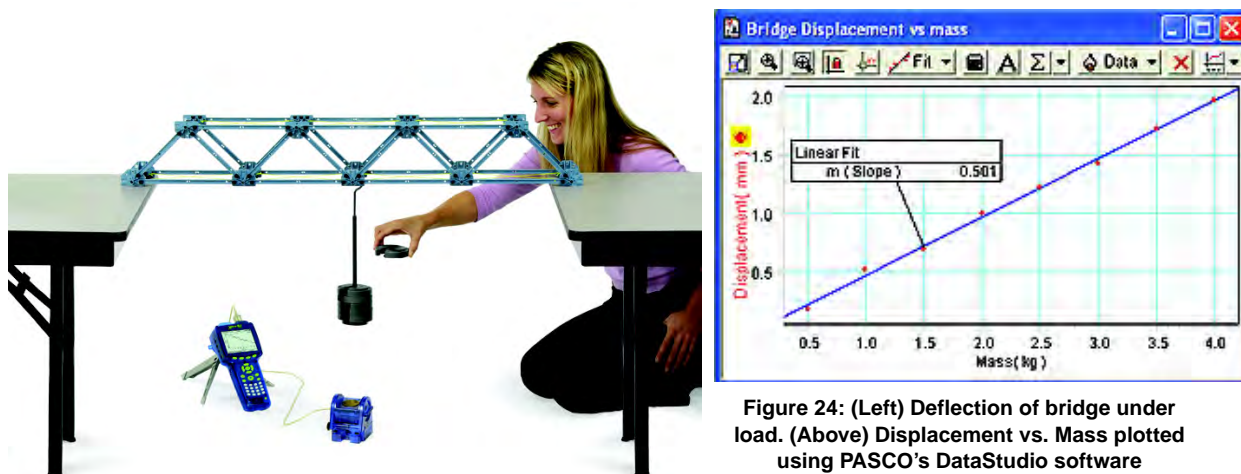

Figure 24: (Left) Deflection of bridge under load. (Above) Displacement vs. Mass plotted using PASCO's DataStudio software

Hint: For the GLX, set the Motion Sensor sample rate to 50 Hz. In the Sensor Setup window, change the 'Reduce/Smooth Averaging' from 'Off' to '5 points'.

Using Load Cells

Figure 25 shows two bridges of the same type but different scale. For a given load the deflection is different. Also note that the forces in some of the members are being measured using load cells to discover the difference caused by the size of the bridge.

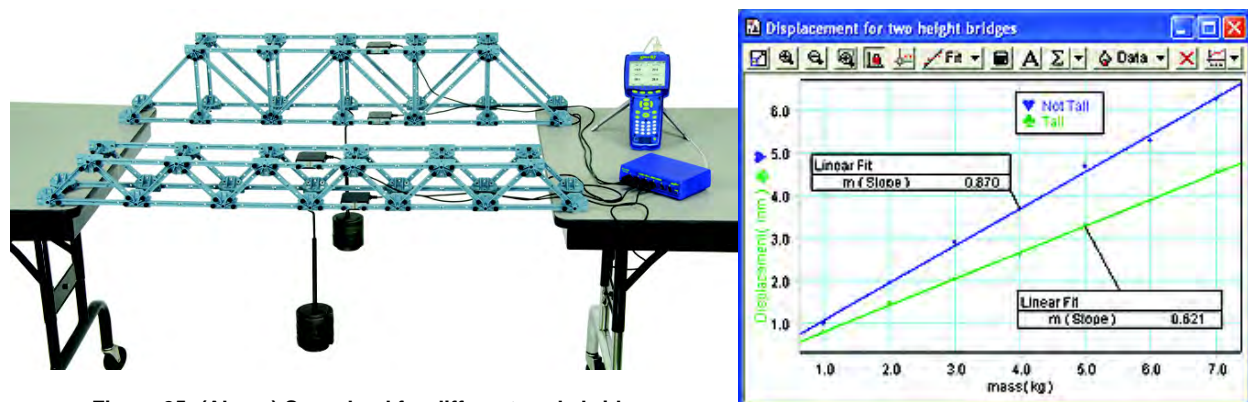

Figure 25: (Above) Same load for different scale bridges. (Right) Displacement vs. mass

Bridge Challenges for Students

Perhaps the best way for students to learn about bridges is to give them a task to accomplish with limited resources by any means possible. Here are two suggestions to challenge your students.

Span a Gap

Give each group a set of plastic, half of a Bridge Set or a Truss Set. The goal is to span a gap of 60 cm. Then find the member with the greatest compression and change the design of the bridge to minimize the maximum compression.

Least Deflection Under Load

Give each group a Bridge Set. The goal is to span a given distance with a bridge that has the least deflection under load. The bridge is loaded with a particular load that the bridge must be able to bear. The bridge that has the least deflection is the winner.

Measuring Static and Dynamic Loading

Static Load

Apply a static load to the bridge by hanging a hooked mass from one of the floor beams and insert load cells into the structure as shown in Figure 26. Loosen all the screws in the structure so the members are resting on their pins. This will eliminate any extra moments due to the screws and the tension and compression readings will agree with the calculated values.

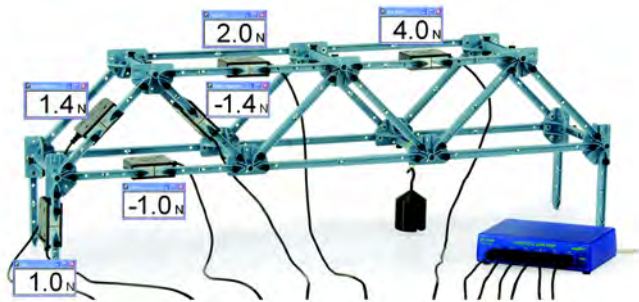

Figure 26: Measuring a Static Load

Dynamic Load

With the load cells inserted as shown in Figure 27, push the Mini-car with its extra mass across the bridge. Zero the load cells before the measurement. Examine which members are under tension or compression.

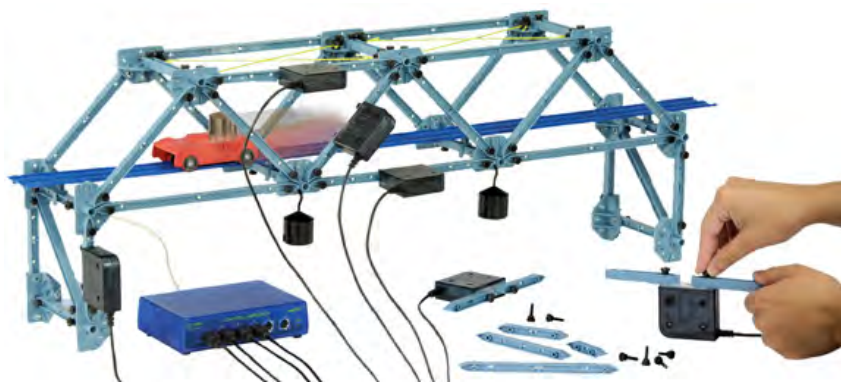
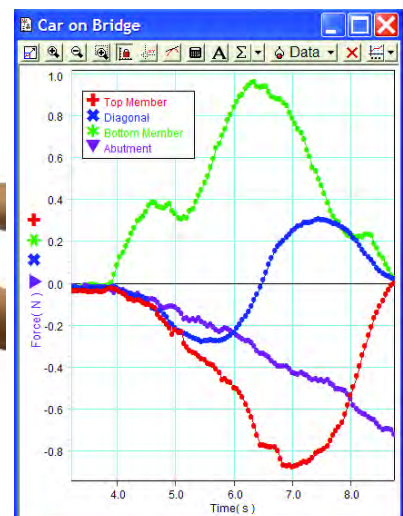

Figure 27: (Above) Recording the forces measured by the load cells as the car traverses the bridge. (Right) DataStudio plot of load cell data



Bridges That Require Two or More Bridge Sets

Note that the Tied Arch Bridge is constructed using the I-beams sideways for the arched part of the bridge. Since the I-beams bend more in this orientation they form a curve. The beams used in this manner will take a set and be permanently bent.



Figure 28: Tied Arch Bridge

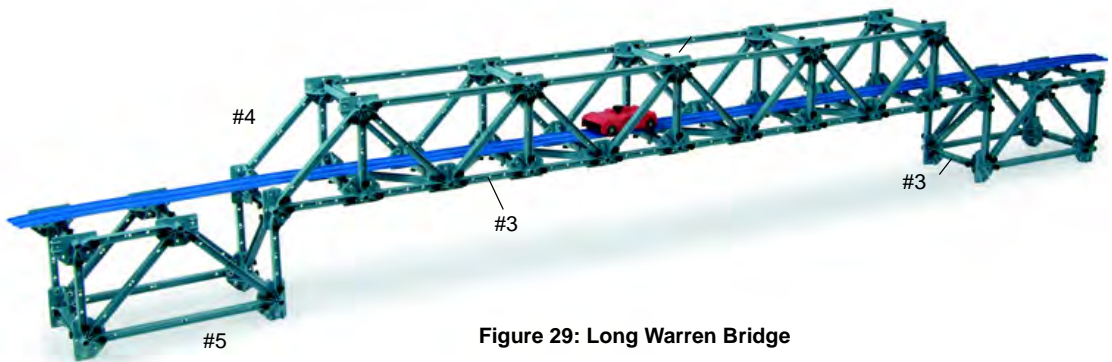

Figure 29: Long Warren Bridge

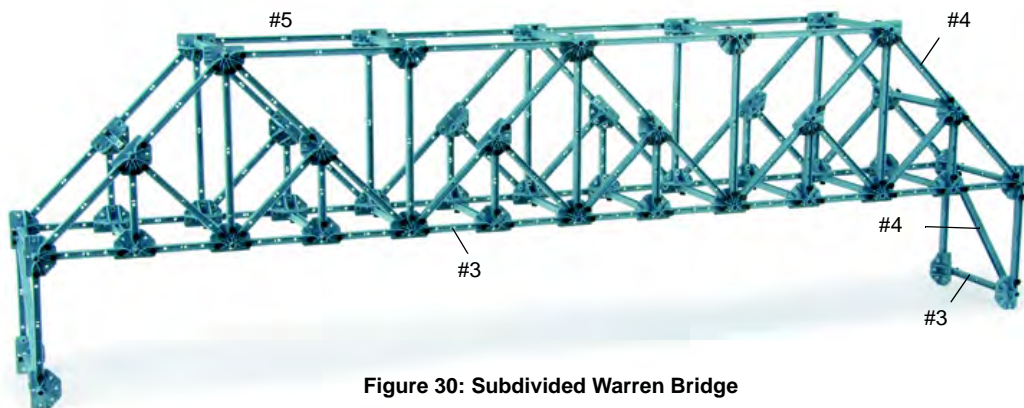

Figure 30: Subdivided Warren Bridge

Dynamics Track

The Bridge Set can be used to construct dynamics systems for studying motion. A straight track can be constructed as shown in Figure 31. Stretching a rubber band across two vertical posts at the end of the track makes a good bumper.

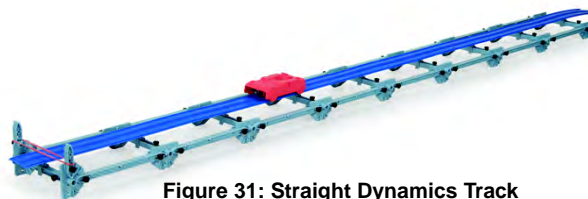

Figure 31: Straight Dynamics Track

Measurement

Motion Sensor

The motion of the Mini-car can be measured using a Motion Sensor (PS-2103). See Figure 32. Provided that the Motion Sensor is closer than 15 cm to the rubber band, the Motion Sensor will not “see” the rubber band and will only register the position of the Mini-car.

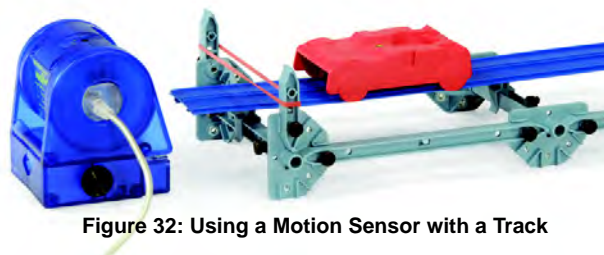

Figure 32: Using a Motion Sensor with a Track

Photogate with Pulley

If a mass hanging over a pulley is used to accelerate the Mini-car, a Photogate can be used with the pulley to measure the rotation of the pulley. The Photogate/Pulley System (ME-6838) and the Table Clamp (ME-8995) are available separately from PASCO. See Figure 33.

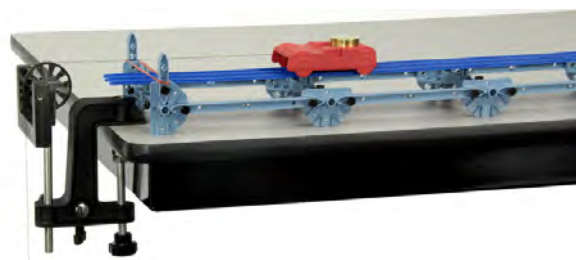

Figure 33: Using a Photogate with Pulley

Ramp and Photogate

A ramp is shown in Figure 34 with a Photogate (ME-9204B) to measure the speed of the Mini-car at the bottom of the ramp during a “Conservation of Energy” experiment. The Mini-car is supplied with a photogate flag that blocks the Photogate’s infrared beam.

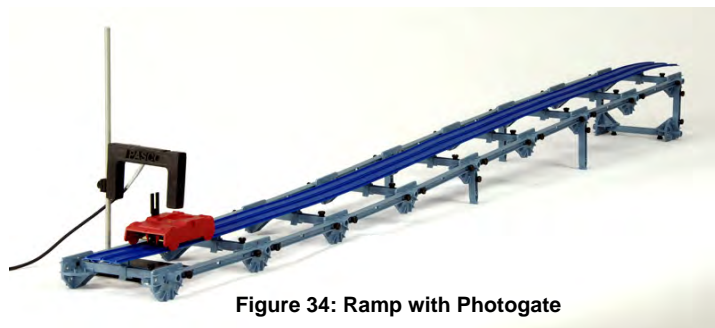

Figure 34: Ramp with Photogate

Rollercoaster Design Challenges

Valley Design Challenge

Design a valley at the bottom of which the Mini-car is going the fastest possible without having the Mini-car leave the track at any point on the track. See figure 35.

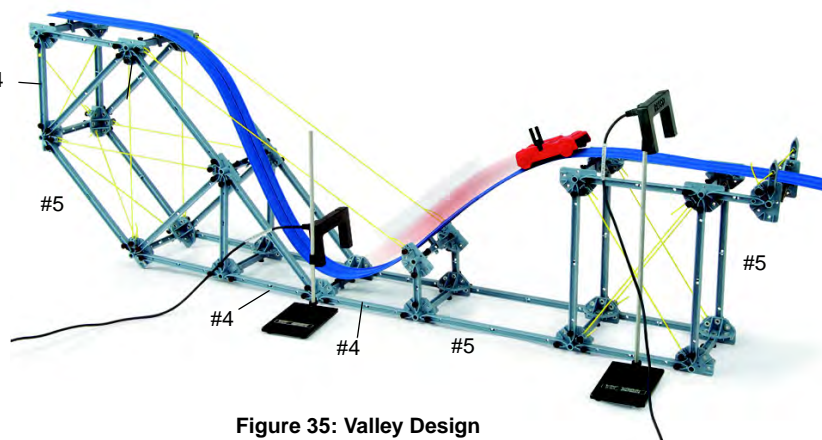

Figure 35: Valley Design

Loop Design Challenge

Design a rollercoaster loop such that the Mini-car makes it around the loop. Measure the forces on the track at the bottom and the top of the loop and make the force zero at the top of the loop. See Figure 36.

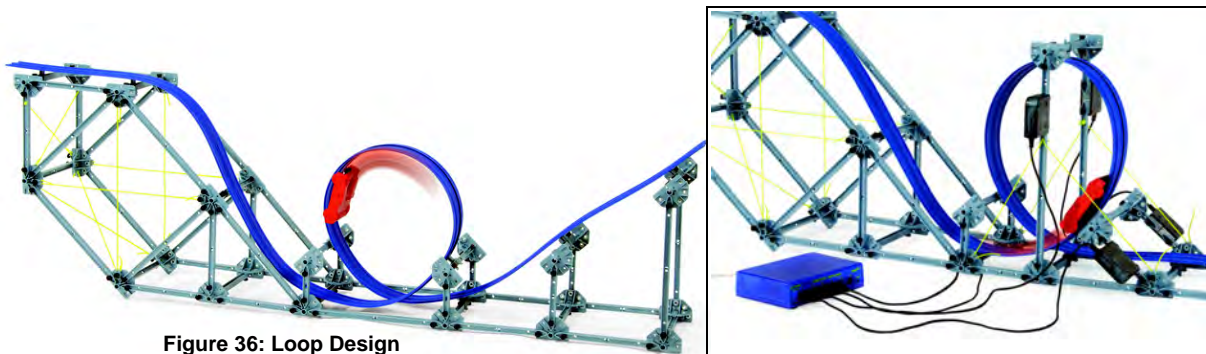

Figure 36: Loop Design

Ski Jump Design Challenge

Design a ramp that will launch the Mini-car as far as possible away from the edge of the table. See Figure 37.

Technical Support

For assistance with any PASCO product, contact PASCO at:

Address: PASCO scientific
10101 Foothills Blvd.
Roseville, CA 95747-7100

Phone: 916-786-3800 (worldwide)
800-772-8700 (U.S.)

Fax: (916) 786-7565

Web: www.pasco.com

Email: support@pasco.com

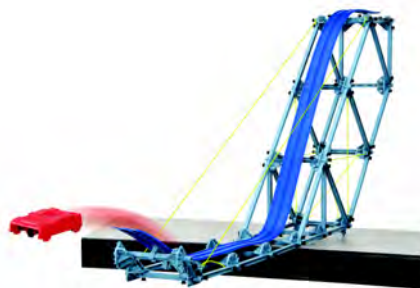

Figure 37: Ski Jump Design

For more information about the Bridge Set and the latest revision of this Instruction Manual, visit:

www.pasco.com/go?ME-6991

Limited Warranty For a description of the product warranty, see the PASCO catalog. **Copyright** The PASCO scientific 012-10656A *Bridge Set Instruction Manual* is copyrighted with all rights reserved. Permission is granted to non-profit educational institutions for reproduction of any part of this manual, providing the reproductions are used only in their laboratories and classrooms, and are not sold for profit. Reproduction under any other circumstances, without the written consent of PASCO scientific, is prohibited. **Trademarks** PASCO and PASCO scientific are trademarks or registered trademarks of PASCO scientific, in the United States and/or in other countries. All other brands, products, or service names are or may be trademarks or service marks of, and are used to identify, products or services of, their respective owners. For more information visit www.pasco.com/legal.