

IR Sensor

PS-2148

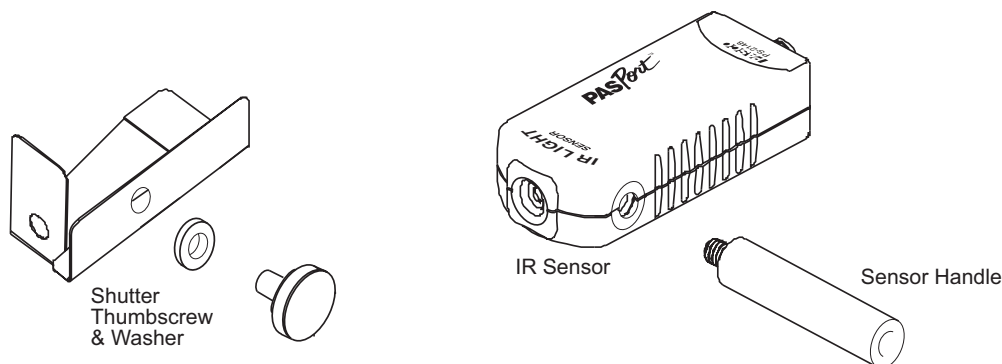

| Included Equipment | Part Number |
|------------------------------------|------------------|
| IR Sensor | PS-2148 |
| Shutter with thumbscrew and washer | 003-08860 |
| Sensor Handle | CI-9874 (4-pack) |

| Additional Equipment Required | |
|--|--|
| PASPORT interface | See PASCO catalog or www.pasco.com |
| DataStudio or DataStudio Lite (required for computer-based data collection) | See PASCO catalog or www.pasco.com DS Lite available for free download |

| Additional Equipment Recommended | |
|----------------------------------|---------|
| PASPORT Extension Cord | PS-2500 |
| Aperture Bracket | OS-8534 |
| Thermal Cavity | TD-8580 |

Introduction

The PASPORT IR Sensor measures infrared radiation intensity over a broad spectrum, allowing students to study a variety of phenomena including blackbody radiation, the Stefan-Boltzmann law, heat flow by radiation, solar radiance and non-contact temperature measurement.

The sensor's silicon-based thermopile encapsulated in nitrogen with a thallium bromide-iodide (KRS-5) window has a flat spectral response from 0.7 to 30 μm . It measures radiation intensity up to 4500 W/m^2 . An integrated thermistor measures the temperature of the detector allowing the user to calculate detector-emitted radiation. In conjunction with a PASPORT interface, the IR Sensor measures and records thermopile voltage, radiation intensity and detector temperature at up to 100 samples per second.

Sensor Setup

Connect the IR sensor to a PASPORT interface either directly, or via a PASPORT extension cord. If you are using a computer, connect the interface to the USB port and start DataStudio.

By default the sampling rate of the sensor is 100 Hz. To change it, go to the Experiment Setup window in DataStudio, or the Sensors screen of the Xplorer GLX. To set up the sensor for estimating the temperature of objects, see “Non-contact Temperature Sensor Simulation” on page 5.

If desired, connect the sensor handle to the $\frac{1}{4}$ -20 threaded connector on the sensor. This connector can also be used with any other $\frac{1}{4}$ -20 screw.

It is not always necessary to attach the shutter, but it can be useful to control the detector temperature. Install the shutter as shown using the included thumbscrew and washer. Or use the sensor handle in place of the thumbscrew.

To measure net IR intensity, point the sensor at a surface or object, such as your hand or the sun, and start data collection in DataStudio or the PASPORT interface. In DataStudio, intensity is automatically shown in a digits display. In DataStudio or on the Xplorer GLX the data can also be displayed in a graph, table, or meter.*

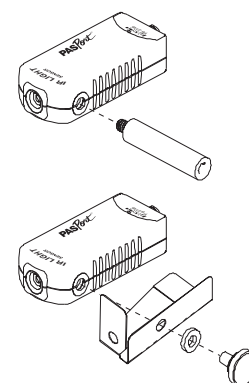

**Sensor Handle
and Shutter
Attachment**

*Refer to the DataStudio Help menu, or the Xplorer GLX Users' Guide for information on setting up data displays.

Background

IR Radiation

All objects emit IR radiation. The radiated power per unit area of an object is given by the Stefan-Boltzmann law:

$$I = \epsilon\sigma T^4$$

Where T is the objects' absolute surface temperature, and σ is the Stefan-Boltzmann constant, equal to $5.670 \times 10^{-8} \text{ W}\cdot\text{m}^{-2}\cdot\text{K}^{-4}$. The emissivity, ϵ , is a property of the object's surface and can range from 0 to 1. An object with $\epsilon = 1$ is described as a blackbody.

Theory of Operation

Consider a blackbody of temperature T_s , whose shape can be approximated as an infinite plane, and a flat detector surface parallel to source with area A_d .

Because radiation from an infinite plane propagates as a plane wave, the power flow from the source to the detector (P_{sd}) equals the radiation emitted by a part of the source whose area is equal to the detector's area, regardless of the distance between the source and detector.

$$P_{sd} = A_d \sigma T_s^4$$

The detector itself also radiates in accordance to the Stefan-Boltzmann law. If the detector's temperature is T_d , then power radiating out of the detector is

$$P_d = A_d \sigma T_d^4$$

Therefore, the *net* power absorbed by the detector is

$$P = A_d \sigma (T_s^4 - T_d^4)$$

The net intensity, which is what the sensor measures, is the net power divided by the detector area.

The net power that flows onto the active detector area by radiation ($P_{sd} - P_d$) flows out of the detector by conduction to other parts of the sensor. A proportion of that power is conducted through the thermopile, which sets up a temperature different (ΔT) across the thermopile. The thermopile produces a voltage (V) that is proportional to ΔT .

If the sensor is warmer than the target source, then net power flows out of the sensor, and ΔT and V are negative.

The net radiated power (P) is proportional the power flow through the thermopile, which is proportional to ΔT , which, in turn, is proportional to V ; therefore, V is proportional to P :

$$V = \mathcal{R} P$$

The constant, \mathcal{R} , is known as the responsivity of the detector. For the PS-2148 sensor, \mathcal{R} is about 31 V/W.

The sensor amplifies the voltage produced by the thermopile and converts it into a digital signal. A microprocessor in the sensor calculates intensity, which is incident power divided by the area of the detector (2.25 mm^2). The thermopile voltage and intensity data are sent digitally to the PASPORT interface or computer.

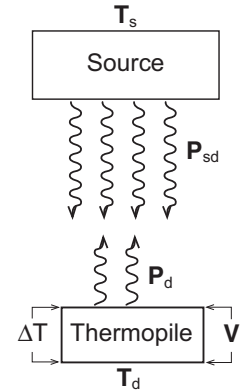

What is a thermopile?

A thermopile is a series of thermocouples

A thermocouple is the junction of two different metals. When two thermocouples are connected in series, and are at different temperatures, a voltage proportional to the temperature difference occurs between them.

This voltage is usually very small. In a thermopile many thermocouples are connected in series (as shown below) to produce a larger voltage. The thermopile in the PS-2148 consists of 120 junctions etched in silicon.

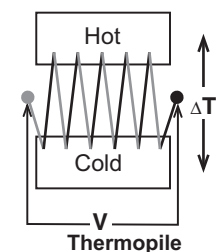
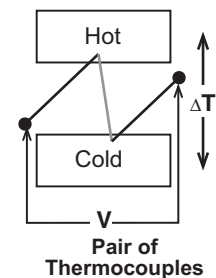

Usage Notes

Field of View

There are two simple arrangements of source object and sensor.

In the first, the source approximates an infinite plane. The radiation propagates from the source as a plane wave, and the intensity does not increase with increasing distance from the source. In this arrangement the radiated power incident on the active area of the sensor is equal to the power emitted by an equivalent area of the source. This approximation is most accurate when the source fills the entire 92° field of view of the sensor.

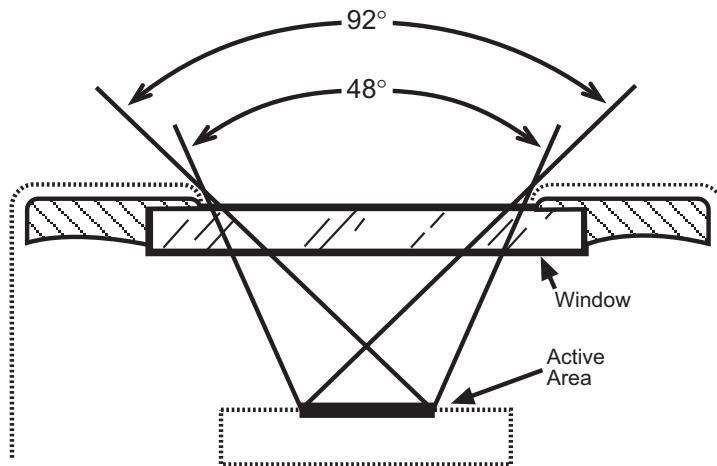

**A plane source should fill the 92° field of view;
A point source should be within the 48° field;
Interfering sources should be outside of the 92° field**

The other simple arrangement is one where the source approximates a point. In this case, the intensity of radiation emitted by the source obeys the inverse-square law. The point source should be within the 48° field of view so that it illuminates the entire active area. Ideally the source should be directly in front of the sensor so that the radiation is normal to the window and to the active area. Other sources of radiation that you wish to ignore should be outside of the 92° field of view.

The Aperture Bracket, OS-8534, can be used to further limit the field of view.

Power and Intensity

The sensor measures net intensity, which is net power divided by the active area of the detector. The formula for net power is $P = I A_d$, where I is the measured net intensity and $A_d = 2.25 \text{ mm}^2$, is the detector area.

The net power equals the incident power from all external sources (P_{sd}) minus the power radiated by the detector, $P = P_{sd} - A_d \sigma T_d^4$.

The temperature of the detector, T_d , is measured by an integrated thermistor.*

Detector Temperature Control

Every time you place the sensor near a hot object, the detector will begin to heat up, and it will cool when you move it away. If you wish to make several intensity measurements at a constant detector

*To make the detector temperature visible in DataStudio, go the Experiment Setup window and select Temperature with units of K. On the Xplorer GLX, go to the Sensors screen.

temperature, allow the detector to cool between each measurement by moving it away from all hot objects. Then place the sensor near the object to be measured and monitor the detector temperature as it increases. Record the intensity when the detector temperature reaches a certain value.

Alternatively, you can mount the shutter on the sensor and control the temperature by opening and closing it.

Non-contact Temperature Sensor Simulation

Based on data collected by the IR sensor, and a calibration constant, you can calculate the temperature of an object.

If the target object approximates a blackbody, then the voltage of the thermopile is

$$V = k (T_s^4 - T_d^4)$$

Where k is a constant that you will determine empirically using an object of known temperature.

You must also know the temperature of the active area of the detector, T_d . The embedded thermistor does not measure T_d directly; rather it measures the temperature of the opposite side of the thermopile ($T_d - \Delta T$). However, since ΔT is always much less than T_d (measured in Kelvin), the thermistor temperature is a good approximation of T_d .*

The constant k depends on several factors unique to each measurement setup including the properties of the particular sensor used, deviation of the target surface from an ideal blackbody, and any intervening medium such as air. For more accurate results, the value of k should be empirically determined with an object of known temperature that is similar to the objects of unknown temperature that you intend to measure.

For the temperature calibration procedure you will need an object of variable temperature, of which you can make a direct temperature measurement. A cup of hot water is a convenient object. Ideally it should have a matte surface so that its emissivity is close to 1.

You will also need a temperature sensor to measure the temperature directly. The PASCO Fast-response Probe (PS-2135) works well because it responds quickly to small changes. Use the probe with a PS-23125 Temperature sensor or any other PASPORT sensor that supports external probes; or connect the probe directly to the temperature port of the Xplorer GLX interface.

Place the IR sensor close to the cup (but not touching) so that the surface of the cup fills the sensor's entire field of view. In this way the surface is seen as an infinite plane, and the distance between the object

*To make the detector temperature visible in DataStudio, go to the Experiment Setup window and select Temperature with units of K.

This measurement is the temperature of the detector. Do not confuse it with the temperature of the target object.

and the sensor is irrelevant. Place the end of the fast-response temperature probe in the cup close to the side that the IR sensor is viewing.

Set up your computer or interface to calculate $(T_s^4 - T_d^4)$, and to graph $(T_s^4 - T_d^4)$ versus thermopile voltage.*

Pour hot water (about 70° C) into the cup. Leave some room for ice, but make sure that the water surface is above the sensor's field of view.

Start data collection.

After a few seconds, add a piece of ice to the cup and stir gently. Continue to add ice, one piece at a time, while stirring, until the temperature has decreased by 20 K or more.

Stop data collection.

Apply a linear fit to the graph of $(T_s^4 - T_d^4)$ versus voltage. The slope of the best-fit line equals k .

Using this value of k , create a calculation of the form:

$$T = (k * V + T_d^4)^{1/4}$$

Where V is the thermopile voltage, and T_d is the detector temperature. Take IR data for an object of unknown temperature; T is the calculated temperature of the object.

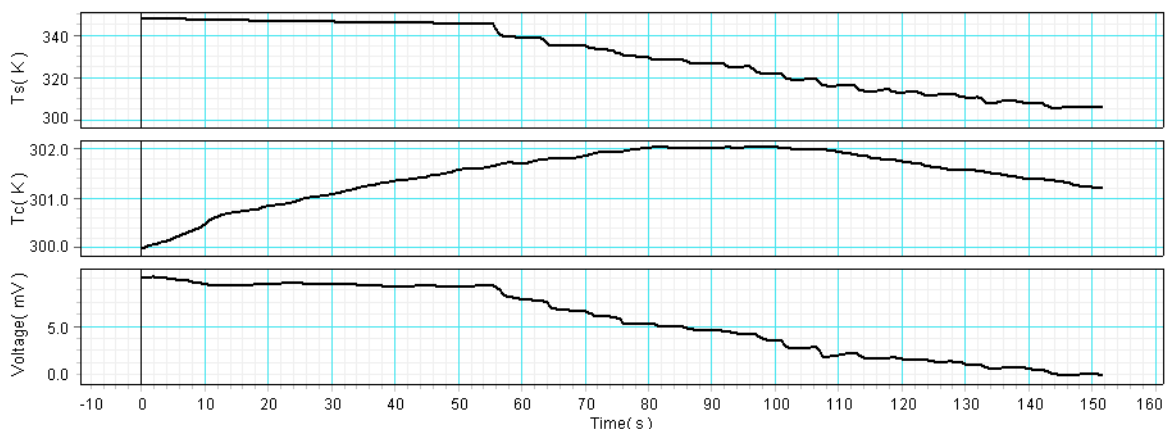

Actual source temperature (top), detector temperature (middle) and voltage (bottom) vs. time as ice is added to hot water

* T_s is the temperature measured by the temperature probe; T_d is the temperature measured by the IR sensor's internal thermistor.

For information on setting up graphs, linear fits, and calculations, refer to the DataStudio Help menu, or the Xplorer GLX Users' Guide.

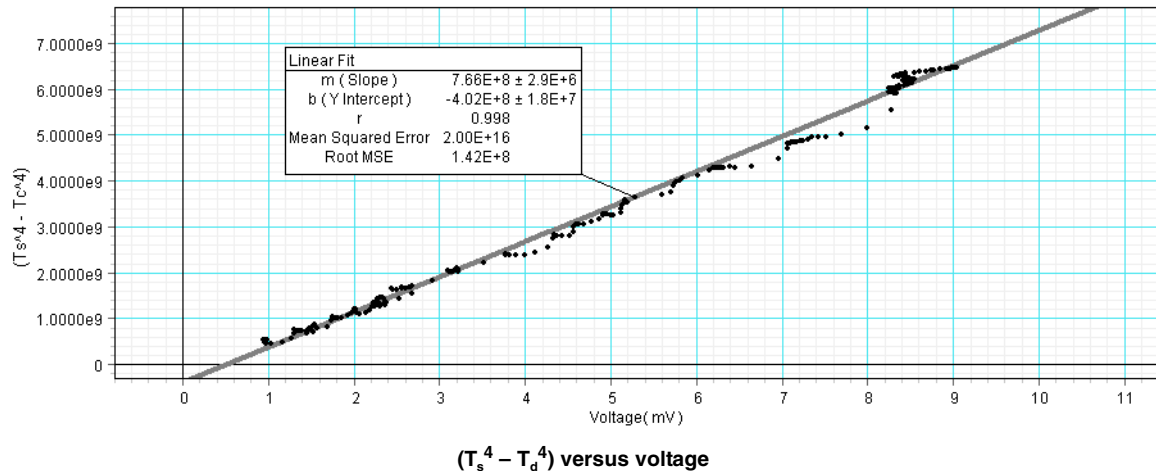

Suggested Activities

Solar Radiation

Measure the radiation intensity from the sun. Compare it to the intensity from a different part of the sky. (When measuring the temperature of the sky, make sure that the sun and other objects such as trees and buildings are not in the field of view.)

How does the presence of clouds, or the angle of the sun in the sky affect solar radiation intensity?

According to your measurement of intensity, what is the total power radiated by the sun? What is its surface temperature?

Intensity vs. Distance

Graph intensity as a function of distance. How does a point source such as the filament of a small light bulb, compare to a larger source such as a hotplate?

Intensity vs. Temperature

How is the temperature of an object (or the temperature difference between the object and the sensor) related to the net intensity?

Cooling

Measure the temperature of a hot object as it cools, and measure the radiation intensity emitted by it. How does the rate of temperature change compare to the total radiated power? How does the total temperature change compare to the total radiated energy? Besides radiation, what are the other mechanisms of heat loss?

Intensity vs. Emissivity

Using the TD-8580 Thermal Cavity, measure the radiation intensity emitted by different surfaces at the same temperature. How do the color and texture of surfaces affect the radiated intensity? Compare the intensity from a surface to the intensity from a cavity of the same temperature.

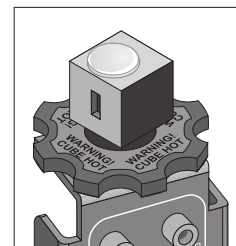

TD-8580 Thermal Cavity

Radiated Power vs. Input Power of a Light Bulb

Measure the voltage and current applied to a small light bulb*, and the radiation intensity emitted by it. Calculate the input electrical power, and the total radiated power. How do they compare?

*PASCO part EM-8627 is a pack of 25 light bulbs that work well for this experiment. They can be used with Light Bulb Sockets (EM-8630, 10-pack), and a power supply capable of 300 mA at 2 V. The PASPORT Voltage/Current Sensor, PS-2115 can be used to measure the electrical power supplied to the bulb.

Second Law of Thermodynamics

The second law of thermodynamics states that heat tends to flow from a hotter object to a cooler object. The objects do not have to be in contact for this to occur because heat can be transferred through radiation.

Measure the net radiation intensity of an object that is cooler than the sensor. In what direction is energy flowing? Allow the cool object and the sensor to come to the same temperature. What happens to the energy flow?

Further Reading

At www.dexterresearch.com follow the “Technical Briefs” link for further information on thermopile detectors and radiometry.

KRS-5 Window Transmittance

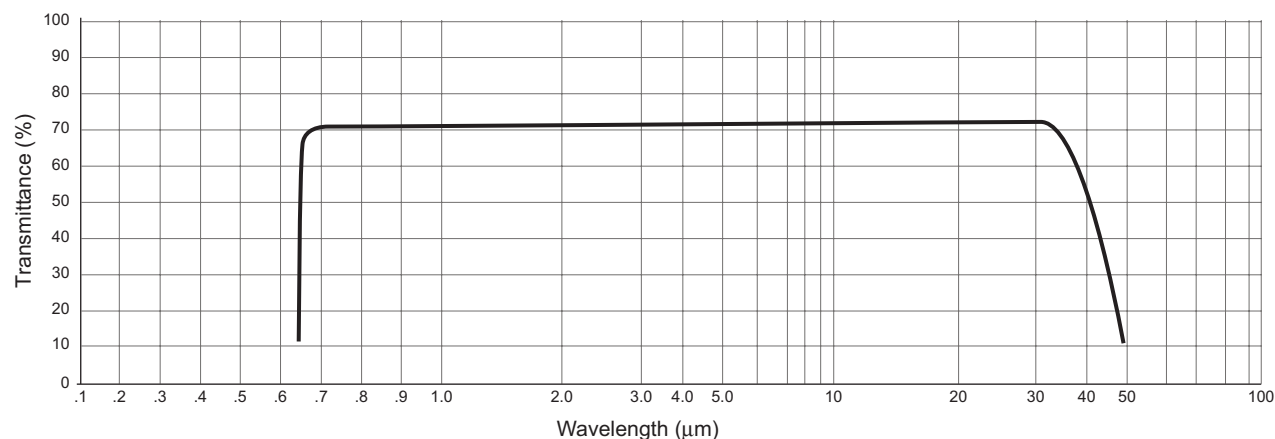

Specifications

| | |
|---|---|
| Active Area Size | 1.5 × 1.5 mm |
| Element Area | 2.25 mm ² |
| Number of Thermocouple Junctions | 120 |
| Field of View | 48° or 92° (see “Field of View” on page 4 for description) |
| Intensity Range | -500 to 4500 W/m ² max. 0 to 1000 W/m ² linear |
| Spectral response | flat from 0.7 to 30 μm |
| Window Material | KRS-5 (see transmittance graph on page 8) |
| Encapsulating Gas | nitrogen |
| Responsivity | 31 ± 7 V/W |

Safety

Read the instructions before using this product. Students should be supervised by their instructors. When using this product, follow the instructions in this manual and all local safety guidelines that apply to you.

Technical Support

For assistance with any PASCO product, contact PASCO at:

Address: PASCO scientific
10101 Foothills Blvd.
Roseville, CA 95747-7100

Phone: (916) 786-3800
(800) 772-8700

Fax: (916) 786-3292

Web: www.pasco.com

Email: techsupp@pasco.com

Limited Warranty

For a description of the product warranty, see the PASCO catalog.

Copyright Notice

The PASCO scientific 012-08852A *IR Sensor Instruction Manual* is copyrighted with all rights reserved. Permission is granted to non-profit educational institutions for reproduction of any part of this manual, providing the reproductions are used only in their laboratories and classrooms, and are not sold for profit. Reproduction under any other circumstances, without the written consent of PASCO scientific, is prohibited.

Author: Alec Ogston



10101 Foothills Blvd. • Roseville, CA 95747-7100
Phone (916) 786-3800 • FAX (916) 786-8905 • www.pasco.com

better
ways to
teach science